

A detailed technical cutaway illustration of a cable connector. It shows a cylindrical metal housing with a threaded cap at the top. Inside, several blue braided shielded cables are visible, along with a black braided shielded cable. The internal components, including a central pin and various contact points, are rendered in a metallic, semi-transparent style. The background is dark, emphasizing the intricate details of the assembly.

2024
PRODUCT
CATALOG

LET'S GO THE EXTRA MILE

Welcome to Elvedes, your trusted partner in the world of cycling. Dedicated to providing premium quality products, we ensure that every bike can be safely brought back to the road. From our base in the Netherlands, we proudly support bicycle manufacturers, wholesalers, and retailers all across the globe.

In the world of cycling and beyond, Elvedes is **your reliable partner for just-in-time deliveries**. Our well-structured stock-keeping strategy of semi-manufactured goods and our advanced assembly facility allows us to deliver innovative, high-quality solutions tailored to the needs of cycling professionals and enthusiasts alike.

This catalog presents an extensive range of our aftermarket products and **serves as a comprehensive handbook** for selecting the right disc brake pads, bearings, and bottom brackets using Elvedes' product guides.

Wherever in the world you're reading this, thank you for choosing Elvedes as your trusted partner. Our product catalog is a gateway to exploring premium quality products as well as an open invitation for new distribution partners to join us on our journey. With craftsmanship and enthusiasm, **we spread the joy of cycling together**.



Canada
Mexico
Costa Rica
Panama
Argentina
South-Africa

United Kingdom
The Netherlands
Belgium
France
Spain
Italy

Switzerland
Germany
Denmark
Poland
Latvia
Estonia

Austria
Slovenia
Croatia
Hungary
Romania
Bulgaria

Greece
Israel
United Arab Emirates



A LITTLE EXTRA

Plus, a word derived from Latin, meaning 'more'. Ever since Elvedes was founded, we have always been striving to do a little more. With the introduction of high steerers for mopeds in the sixties, the existing moped cables needed some more length. The demand caused Elvedes to add more different cables to the range, not only for mopeds and bicycles, but for all kinds of purposes, made to measure.

Through the years, more and more of bicycle service parts have been added to the range. Convenient displays for more overview and an organized workshop. Disc brake pads, but more than just the most common ones. Rim brake pads, but also with special compounds which are more silent and more powerful. Twist fit bottom brackets, which not only add more stability to the bearings, but are also more durable because the bearings themselves can be replaced when worn. And many more.

We think that these smart additions and solutions would make the life of the mechanic or consumer just that little more convenient. To put these items to everyone's attention some more, we introduce the Elvedes + label, by which they can easily be recognized throughout this catalog. The label, along with a single highlighted sentence, explains why that particular item is such a big plus.



Elvedes +

This label can be found at different items throughout the catalog. It tells you why this particular item is such a big plus.

INDEX

04	BRAKE
05	DISC BRAKE SYSTEMS
07	CALIPER ADAPTERS
08	CALIPER BOLTS
09	DISC BRAKE ROTORS
12	DISC BRAKE PARTS
13	DISC BRAKE PADS
22	RIM BRAKE PADS
26	CABLE
27	INNER CABLES
30	SUPERFLEX
32	OUTER CABLES
33	CABLE KITS
37	CABLE PARTS
42	HYDRO
43	ORIGINAL BRANDS
46	HYDRO COMPONENTS
48	SHIMANO HYDRO COMPONENTS
49	O-RINGS
50	ROTATION
50	BEARINGS
52	HEADSET BEARINGS
54	HEADSET PARTS
55	PULLEY WHEELS
57	BOTTOM BRACKET GUIDE
61	BOTTOM BRACKETS
64	BOTTOM BRACKET PARTS
66	TOOLS AND MAINTENANCE
66	MAINTENANCE
67	CABLE TOOLS
68	HYDRO TOOLS
72	MORE TOOLS
73	BOTTOM BRACKET TOOLS
74	WORKSHOP
75	TRANSIT
76	BOXER
77	PARTNER
78	CADDY
79	PADFINDER
80	DISCOVERY
82	BLEED STATION

BRAKE



MP1000 MECHANICAL DISC BRAKE CALIPER 2017130

Post mount
1 pce

Dual piston disc brake caliper

For optimal performance, use with:
2010016 outer cable
1160 CNC ferrules
1,8 – 1,9mm rotor thickness

Replacement disc brake pads: 6894 model



MP1000 MECHANICAL DISC BRAKE CALIPER 2019097

Flat mount
1 pce

Dual piston disc brake caliper

For optimal performance, use with:
2010016 outer cable
1160 CNC ferrules
1,8 – 1,9mm rotor thickness

Replacement disc brake pads: 6907 model



MP1000 MECHANICAL DISC BRAKE CALIPER 2019098

Post mount TWIN
1 pair left + right

Dual piston disc brake caliper

For optimal performance, use with:
2010016 outer cable
1160 CNC ferrules
1,8 – 1,9mm rotor thickness

Replacement disc brake pads: 6894 model



Left

Right

MECHANICAL DISC BRAKE LEVER

2,5 - 3 finger
Ø23mm

- 2017131 Left + right hand 1 pair
- 2018054 Left hand 1 pce
- 2018055 Right hand 1 pce



DUAL BRAKE LEVER WITH PARKING STOP

3 finger
Ø23mm

- 2010015 Right hand 1 pce



BRAKE

DISC BRAKE SYSTEMS

- CALIPER ADAPTERS
- CALIPER BOLTS
- DISC BRAKE ROTORS
- DISC BRAKE PARTS
- DISC BRAKE PADS
- RIM BRAKE PADS

CABLE

- INNER CABLES
- SUPERFLEX
- OUTER CABLES
- CABLE KITS
- CABLE PARTS

HYDRO

- ORIGINAL BRANDS
- HYDRO COMPONENTS
- SHIMANO HYDRO COMPONENTS
- O-RINGS

ROTATION

- BEARINGS
- HEADSET BEARINGS
- HEADSET PARTS
- PULLEY WHEELS
- BOTTOM BRACKET GUIDE
- BOTTOM BRACKETS
- BOTTOM BRACKET PARTS

TOOLS AND MAINTENANCE

- MAINTENANCE
- CABLE TOOLS
- HYDRO TOOLS
- MORE TOOLS
- BOTTOM BRACKET TOOLS

WORKSHOP

- TRANSIT
- BOXER
- PARTNER
- CADDY
- PADFINDER
- DISCOVERY
- BLEED STATION

DISC BRAKE SYSTEMS

HP4000 HYDRAULIC DISC BRAKE SET

2017132

Mineral oil system
2.5 - 3 finger lever
Dual piston disc brake caliper

Replacement disc brake
pads for HP4000:
6890 model

Replacement
Ø160mm rotor: 2018053

Spare hose fitting set
for HP4000: CP2020139

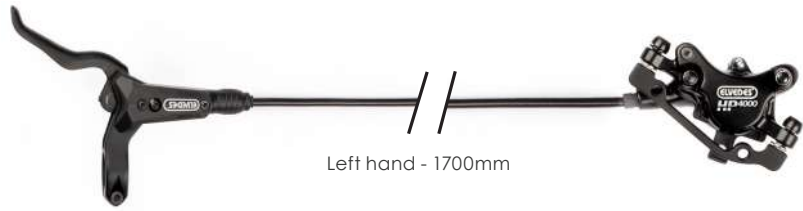

Left hand - 1700mm

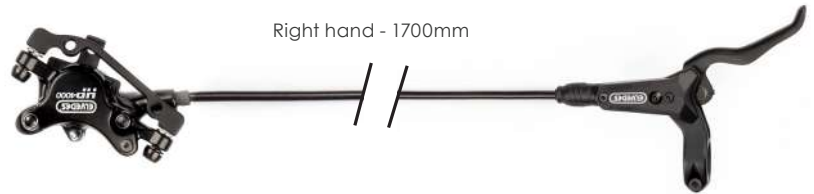

Right hand - 1700mm



HP4000 HYDRAULIC DISC BRAKE SET LEFT HAND

2018108



Left hand - 1700mm

HP4000 HYDRAULIC DISC BRAKE SET RIGHT HAND

2018107



Right hand - 1700mm

HP4000 BLEED BLOCK

2022081



How to bleed the
HP4000 system



CALIPER ADAPTER

Adapter types are indicated caliper to frame (e.g. PM-IS = PM caliper to IS frame/fork)
Bolts are included with every adapter



CP2017072

PM - IS
Ø180 front
Ø160 rear



CP2015162

PM - IS
Ø203 front



CP2022067

PM - IS
Ø220 rear



CP2016117

PM - PM after 2013
Ø140 → Ø160
Ø160 → Ø180



CP2018058

PM - PM
Ø180 → Ø203



CP2022065

PM - PM
Ø180 → Ø220



CP2019046

FM - PM
Ø140 front



CP2019048

FM - PM
Ø160 front



CP2019044

FM - FM
Ø140 front
Ø160 front



CP2017071

PM - IS
Ø160 front
Ø140 rear



CP2015167

PM - IS
Ø180 rear



CP2015168

PM - IS
Ø203 rear



CP2015158

PM - PM after 2013
Ø180



CP2015159

PM - PM
Ø160 → Ø203



CP2022064

PM - PM
Ø160 → Ø220



CP2022066

PM - PM
Ø203 → Ø220



CP2019047

FM - PM
Ø140 rear



CP2019045

FM - PM
Ø160 rear



CP2017160

FM - FM
Ø160 rear



BRAKE

DISC BRAKE SYSTEMS

CALIPER ADAPTERS

- CALIPER BOLTS
- DISC BRAKE ROTORS
- DISC BRAKE PARTS
- DISC BRAKE PADS
- RIM BRAKE PADS

CABLE

- INNER CABLES
- SUPERFLEX
- OUTER CABLES
- CABLE KITS
- CABLE PARTS

HYDRO

- ORIGINAL BRANDS
- HYDRO COMPONENTS
- SHIMANO HYDRO COMPONENTS
- O-RINGS

ROTATION

- BEARINGS
- HEADSET BEARINGS
- HEADSET PARTS
- PULLEY WHEELS
- BOTTOM BRACKET GUIDE
- BOTTOM BRACKETS
- BOTTOM BRACKET PARTS

TOOLS AND MAINTENANCE

- MAINTENANCE
- CABLE TOOLS
- HYDRO TOOLS
- MORE TOOLS
- BOTTOM BRACKET TOOLS

WORKSHOP

- TRANSIT
- BOXER
- PARTNER
- CADDY
- PADFINDER
- DISCOVERY
- BLEED STATION

CALIPER BOLTS

FLATMOUNT BOLTS FOR SHIMANO

2022052

M5 × 23mm
2 pieces



2022053

M5 × 28mm
2 pieces



2022054

M5 × 33mm
2 pieces



2022055

M5 × 38mm
2 pieces



2022056

M5 × 43mm
2 pieces



2022057

M5 × 48mm
2 pieces



FLATMOUNT BOLTS

2021113

M5 × 23mm
2 pieces



2021114

M5 × 28mm
2 pieces



2021115

M5 × 33mm
2 pieces



2021116

M5 × 38mm
2 pieces



2021117

M5 × 43mm
2 pieces



2021118

M5 × 48mm
2 pieces



2022021

FM adapter bolts
M5 × 8mm
2 pieces



2022020

PM bolts
M6 × 20mm
2 pieces



2022019

PM bolts
M6 × 35mm
M6 × 40mm
1 set



BRAND	MODELS	THICKNESS
Formula	All models	1,8 mm
Hayes	All models	1,8 mm
Hope	All models	1,8 mm
Shimano	All models	1,8 mm
SRAM/Avid	All models	1,8 mm
Magura	All models	2,0 mm
Tektro	TR-16, 19, 22, 24, 35, 46, 47, 52, 53	1,8 mm
	TR-17, 45, 47E, 54	2,3 mm
TRP	RC03M	1,8 mm
	RS01M, RS02M	1,8 mm
	TR-25, 29, 33	1,8 mm
	RC01E, 03E, 04E	2,3 mm
	RS01E	2,3 mm
	TR-42	2,3 mm

SC ROTOR

Stainless steel with aluminium Centra-lock

Thickness: 1,8mm

2020071	SC14	Ø140 mm	130 g
2020072	SC16	Ø160 mm	154 g
2020073	SC18	Ø180 mm	180 g
2020116	SC20	Ø203 mm	230 g



SX ROTOR

Stainless steel, 6 holes, including rotor bolts

Thickness: 1,8mm

2014069	SX14	Ø140 mm	86 g
6820	SX16	Ø160 mm	138 g
6821	SX18	Ø180 mm	151 g
2017092	SX20	Ø203 mm	188 g

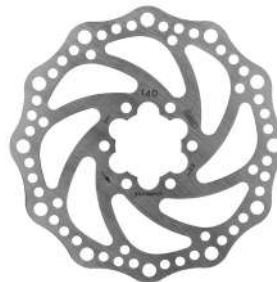

HP ROTOR

Stainless steel, 6 holes, including rotor bolts

Thickness: 1,8mm

2018053	HP16	Ø160 mm	96 g
2019057	HP18	Ø180 mm	127 g



BMX ROTOR

Stainless steel, 6 holes, including rotor bolts

Thickness: 1,8mm

2019055	Ø120 mm
----------------	---------



BRAKE

DISC BRAKE SYSTEMS

CALIPER ADAPTERS

CALIPER BOLTS

DISC BRAKE ROTORS

DISC BRAKE PARTS

DISC BRAKE PADS

RIM BRAKE PADS

CABLE

INNER CABLES

SUPERFLEX

OUTER CABLES

CABLE KITS

CABLE PARTS

HYDRO

ORIGINAL BRANDS

HYDRO COMPONENTS

SHIMANO HYDRO COMPONENTS

O-RINGS

ROTATION

BEARINGS

HEADSET BEARINGS

HEADSET PARTS

PULLEY WHEELS

BOTTOM BRACKET GUIDE

BOTTOM BRACKETS

BOTTOM BRACKET PARTS

TOOLS AND MAINTENANCE

MAINTENANCE

CABLE TOOLS

HYDRO TOOLS

MORE TOOLS

BOTTOM BRACKET TOOLS

WORKSHOP

TRANSIT

BOXER

PARTNER

CADDY

PADFINDER

DISCOVERY

BLEED STATION

LX LIGHT WEIGHT ROTOR

Stainless steel, 6 holes, including rotor bolts

Thickness: 1,8mm

2021066	Stainless	Ø160 mm	85 g
2021067	Stainless	Ø180 mm	112 g



RX FLOATING ROTOR

Stainless steel and aluminium, 6 holes, including rotor bolts

Thickness: 1,8mm

2015152	RX14	Ø140 mm	96 g
2015206	RX16	Ø160 mm	120 g
2015207	RX18	Ø180 mm	148 g
2015208	RX20	Ø203 mm	196 g



LIGHT WEIGHT 6-HOLE ROTOR

Stainless steel, aluminium core, excluding rotor bolts

Thickness: 1,8mm

2023022	Ø140 mm	85 g
2023023	Ø160 mm	105 g

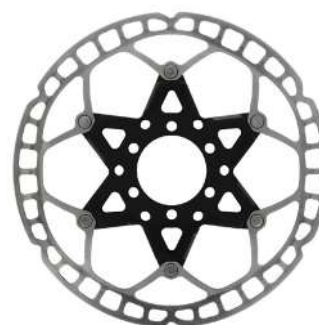

LIGHT WEIGHT CENTRA-LOCK ROTOR

Stainless steel, aluminium core, excluding lock-ring

Thickness: 1,8mm

2023024	Ø140 mm	99 g
2023025	Ø160 mm	117 g

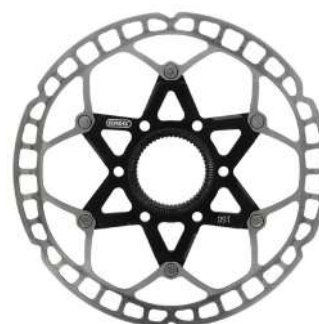

6-HOLE ROTOR

Stainless steel, excluding bolts

2023026	Ø160 mm	1,8 mm
2023027	Ø180 mm	1,8 mm
2023028	Ø203 mm	1,8 mm
2023029	Ø220 mm	1,8 mm
2023030	Ø160 mm	2,0 mm
2023031	Ø180 mm	2,0 mm
2023032	Ø203 mm	2,0 mm
2023033	Ø220 mm	2,0 mm
2023035	Ø180 mm	2,3 mm
2023036	Ø203 mm	2,3 mm
2023037	Ø220 mm	2,3 mm

CENTRA-LOCK ROTOR

Stainless steel, excluding lock-ring

2023038	Ø160 mm	1,8 mm
2023039	Ø180 mm	1,8 mm
2023040	Ø203 mm	1,8 mm
2023041	Ø220 mm	1,8 mm
2023042	Ø160 mm	2,0 mm
2023043	Ø180 mm	2,0 mm
2023044	Ø203 mm	2,0 mm
2023045	Ø220 mm	2,0 mm
2023047	Ø180 mm	2,3 mm
2023048	Ø203 mm	2,3 mm
2023049	Ø220 mm	2,3 mm

6-HOLE ROTOR WITH SENSOR MAGNET

Stainless steel, excluding bolts

2023050	Ø160 mm	1,8 mm
2023051	Ø180 mm	1,8 mm
2023052	Ø203 mm	1,8 mm



CENTRA-LOCK ROTOR WITH SENSOR MAGNET

Stainless steel, excluding lock ring

2023054	Ø160 mm	1,8 mm
2023055	Ø180 mm	1,8 mm
2023056	Ø203 mm	1,8 mm



BRAKE

DISC BRAKE SYSTEMS

CALIPER ADAPTERS

CALIPER BOLTS

DISC BRAKE ROTORS

DISC BRAKE PARTS

DISC BRAKE PADS

RIM BRAKE PADS

CABLE

INNER CABLES

SUPERFLEX

OUTER CABLES

CABLE KITS

CABLE PARTS

HYDRO

ORIGINAL BRANDS

HYDRO

COMPONENTS

SHIMANO HYDRO

COMPONENTS

O-RINGS

ROTATION

BEARINGS

HEADSET BEARINGS

HEADSET PARTS

PULLEY WHEELS

BOTTOM BRACKET

GUIDE

BOTTOM BRACKETS

BOTTOM BRACKET

PARTS

TOOLS AND MAINTENANCE

MAINTENANCE

CABLE TOOLS

HYDRO TOOLS

MORE TOOLS

BOTTOM BRACKET

TOOLS

WORKSHOP

TRANSIT

BOXER

PARTNER

CADDY

PADFINDER

DISCOVERY

BLEED STATION

ROTOR ACCESSORIES

CP2012048

CNC Centra-lock
Adapter with lock ring
Aluminium
1 pce



2021068

CNC Centra-lock
Lock ring
Aluminium
1 pce



2023012

Centra-lock shim
0,1 mm
Stainless steel
4 pcs



2023013

Centra-lock shim
0,2 mm
Stainless steel
4 pcs



2019068 0,1 mm

2019054 0,2 mm
Rotor shim
Stainless steel
8 pcs



2017149

Rotor shim
1,0 mm
Stainless steel
1 pce



CP2015153

Rotor bolt
Torx head
Titanium CNC
6 pcs



2017187 12 pcs

ELV2015157 100 pcs
Rotor bolt
Torx head
Stainless steel



2023077

Rotor magnet for sensor
Spare part
incl. fasteners
1 set



PINS AND CLIPS

2017178

Set screw
Magura Marta,
Gustava, Louise
2007

M4×22,5
10 pcs



2017179

Fixing pin
Shimano Deore,
Avid Elixir 1/3

35mm
10 pcs



2017180

Fixing pin
Hayes, Hope

45mm
10 pcs



2017181

Fixing bolt
Avid Elixir 5/7/9,
Guide, Code, Trail

M4×22
10 pcs



2017182

Fixing bolt
Shimano XT, XTR,
Magura MT 2/4/6/8,
Tektro, Formula Oro

M4×27
10 pcs



2017183

Fixing bolt
Hayes Ryde,
Dyno

M4×36
10 pcs



2017184

Fixing bolt
Formula Mega,
Hope E4/V4/
X2/V2
M5×25
10 pcs



2020247

Clip

M4/M5
10 pcs



2020248

Clip

SRAM
10 pcs



DISC BRAKE PAD GUIDE

HOW TO EXTEND THE LIFETIME OF YOUR DISC BRAKE PADS

Bed-in disc brake pads extend the life span of the pads considerably! Squeeze them in carefully and ensure that the pad just audibly touches the brake disc for approximately 100 metres at a speed of ± 25 km/hour. Now squeeze a little harder on the brake so that the speed decreases to approximately 5 km/hour, and then slowly increase the speed while gently squeezing the brake. Repeat this 10-12 times and the pads are worn in. Never brake to a stop with the brake still squeezed in order to prevent damage to the rotor. Always bed-in the front and rear brakes separately.

GREY

- + Super soft compound
- + Noise reducing
- + For any noisy disc brake
- + Excellent problem solver



BLUE

- + Soft compound
- + Comfortable and reliable
- + For gravel bike, road bike, trekking bike and MTB
- + Excellent for daily and sporty use



BLACK

- + Medium compound
- + Powerful
- + For cargo bike, e-bike and MTB
- + Excellent for heavy duty



GOLD

- + Hard compound
- + Wear and heat resistant
- + For commercial cargobike, e-bike and downhill MTB
- + Excellent for intensive use



BRAKE

DISC BRAKE SYSTEMS

CALIPER ADAPTERS

CALIPER BOLTS

DISC BRAKE ROTORS

DISC BRAKE PARTS

DISC BRAKE PADS

RIM BRAKE PADS

CABLE

INNER CABLES

SUPERFLEX

OUTER CABLES

CABLE KITS

CABLE PARTS

HYDRO

ORIGINAL BRANDS

HYDRO COMPONENTS

SHIMANO HYDRO COMPONENTS

O-RINGS

ROTATION

BEARINGS

HEADSET BEARINGS

HEADSET PARTS

PULLEY WHEELS

BOTTOM BRACKET GUIDE

BOTTOM BRACKETS

BOTTOM BRACKET PARTS

TOOLS AND MAINTENANCE

MAINTENANCE

CABLE TOOLS

HYDRO TOOLS

MORE TOOLS

BOTTOM BRACKET TOOLS

WORKSHOP

TRANSIT

BOXER

PARTNER

CADDY

PADFINDER

DISCOVERY

BLEED STATION

ORDER QUANTITY

All organic, sintered and metallic carbon disc brake pads have a steel backplate.

XXXX -CARD

All disc brake pads can be ordered per card, containing 1 pair.

Necessary pins and clips included with all types of disc brake pads on card.

Fits Discovery display (page 80 - 81)



XXXX -BOX

Selected disc brake pads can be ordered per box, containing 10 pairs

Fits Padfinder display (page 79)



XXXX -BOX25

Selected disc brake pads can be ordered per box, containing 25 pairs.

Fits Padfinder display (page 79)



DISC BRAKE PADS

BRAND	MODEL	GREY	BLUE	BLACK	GOLD
Alhonga	SNG mechanical		6872	6872MC	
	C420, C425, C470		6886	6886MC	
Assess	C430		6881		
	BB3, BB5		6886	6886MC	
Avid	BB7, Juicy		6855	6855MC	6855S
	Code, Code 5		6882		
	Code > 2011		6895	6895MC	6895S
	DB1, DB3	6906T	6906	6906MC	6906S
	Elixir	6890T	6890	6890MC	6890S
	X0, X7, X9 Trail		6898	6898MC	6898S
Campagnolo		6908T			
Cannondale	Coda		6865		
	Clout 1, S2		6854	6854MC	6854S
Clarks	M1, M2, M3, CMD-22(FM), CMD-23, CMD-27	6894T	6894	6894MC	6894S
	M4	6891T	6891	6891MC	6891S
	Exo, Skeletal		6860		
	CMD-24, HDB-540, HDB-600, HDB-790	6859T	6859		6859S
	CMD-9, CMD-17(R)		6886	6886MC	
	CMD-15		6855	6855MC	6855S
Cowboy	CMD-5, CMD-6, CMD-7, CMD-12		6913		
	Cruiser (ST), C2, C3, Classic	6907T	6907	6907MC	6907S
Diatech	Anchor		6880		
	Twincam		6864		
Elvedes	HP4000	6890T	6890	6890MC	6890S
	MP1000 PM	6894T	6894	6894MC	6894S
	MP1000 FM	6907T	6907	6907MC	6907S
Formula	4-Racing, B4 Team		6869		
	C1, Cura, Cura-E, Mega, R1 (R), RO (R), RX, The One		6893	6893MC	6893S
	Cura 4		6909	6909MC	6909S
	Extreme		6869		
	Evoluzione		6867		
	Oro		6863		6863S
Giant	MPH 2000		6852		
	MPH 2001 - 2003, MPH-2, MPH-3		6861		
	Root		6854	6854MC	6854S
Grimeca	System 8, 12, 16		6853		
	System 13		6869		
	Dominion A4		6910	6910MC	6910S
Hayes	Dyno, Stroker Ryde		6888		6888S
	El Camino		6885		
	HFX, MX 1		6850		6850S
	Prime		6896		6896S
	Stroker Ace		6892		
	Stroker Carbon, Gram, Trail, GX2		6889		6889S
	MX2, MX3, MX4, Sole	6862T	6862	6862MC	
Hope	C2, O2		6852		
	DH4, M4 2002		6871		
	E4, RX4-SH		6903		
	Mini		6870		
	Mono 6 2007, 6-Ti 2004, Moto M6		6876		
	Mono M4		6853		
	Mono Mini		6877		
	Mono Trial, Trial Zone		6887		
	(Moto) V2		6883		
	V4		6899		6899S
Logan	X2		6911	6911MC	6911S
	XC4		6873		
Magura			6874		
	Clara 2000 - 2001, Louise 1999 - 2001		6851		
	Clara 2001 - 2002, Louise (FR) 2002 - 2006		6857		
	Gustav M 2000 - 2011		6878		
	Julie 2001 - 2008		6856		
	Julie HP, Louise > 2007, Louise Bat, Louise Carbon, Marta > 2009		6884		6884S
	Marta 2002 - 2008, Marta SL 2003 - 2008		6860		
	MT2, MT4, MT6, MT8, MT Sport	6897T	6897	6897MC	6897S
		6902T	6902	6902MC	6902S
	MT5, MT7, MT C5, MT Thirty		6904		
Promax	DC320, 610, 610J, 700, DSK400, 601J, Xnine		6879		
	DC600		6850		6850S
	DC710, 720, 913, Decipher, DSK-300(R), 310, 330R, 715, Render (R)		6886	6886MC	
	DC901, 951		6880		
	DC905, 907, 908, DSK-950		6855	6855MC	6855S
	DC910		6851		
	Decode R DSK-718R, DSK-909, E-Capsule, F1, Lucid, Solve		6854	6854MC	6854S
DA	6862T	6862	6862MC		
Quad	Lucid P4		6853		
	QHD-1		6854	6854MC	6854S
RST	D-Power		6854	6854MC	6854S
	DA		6866		

DISC BRAKE PADS

BRAND	MODEL	GREY	BLUE	BLACK	GOLD
Shimano	105 BR-R7070, 7170, BR-RS505	6907T	6907	6907MC	6907S
	Acera BR-M3050	6854T	6854	6854MC	6854S
	Alfine BR-S500, 501	6859T	6859		6859S
	Alfine BR-S700, 7000	6894T	6894	6894MC	6894S
	Alivio BR-M395, 446, 4050	6854T	6854	6854MC	6854S
	Altus BR-M315, 365, 375	6854T	6854	6854MC	6854S
	BR-CX75, 77, BR-R515, 517	6894T	6894	6894MC	6894S
	BR-M355, 415, 416, 416A, 445, 447, 465, 475, 485, 486, 495, 575,	6854T	6854	6854MC	6854S
	BR-MT200, 400, 410, 500, BR-UR300				
	BR-M545, BR-R505, BR-T605	6859T	6859		6859S
	BR-MT420, 520	6891T	6891	6891MC	6891S
	BR-RS305	6907T	6907	6907MC	6907S
	Deore BR-M515, 515LA, 525, BR-T615	6854T	6854	6854MC	6854S
	Deore BR-M535, 595, 596	6859T	6859		6859S
	Deore BR-M555		6858		
	Deore BR-M615, 6000, 6100, BR-R785, BR-RS785	6894T	6894	6894MC	6894S
	Deore BR-M6120	6891T	6891	6891MC	6891S
	Deore LX BR-M585, BR-T665	6859T	6859		6859S
	Deore LX BR-T675	6854T	6854	6854MC	6854S
	Deore XT BR-M755, 755-DH		6853		
	Deore XT BR-M765, 775, 776	6859T	6859		6859S
	Deore XT BR-M785, 8000, 8100	6894T	6894	6894MC	6894S
	Deore XT BR-M8020, 8120	6891T	6891	6891MC	6891S
	Deore XT BR-M8110	6907T	6907	6907MC	6907S
	Dura-ace BR-R9170, 9270	6907T	6907	6907MC	6907S
	GRX BR-RX400, 810	6907T	6907	6907MC	6907S
	Hone BR-M601	6859T	6859		6859S
	Metrea BR-U5000	6907T	6907	6907MC	6907S
	Nexave BR-C501, 601	6854T	6854	6854MC	6854S
	Nexave BR-C901		6858		
	Saint BR-M757	6854T	6854	6854MC	6854S
	Saint BR-M800	6859T	6859		6859S
	Saint BR-M810, 820	6891T	6891	6891MC	6891S
	SLX BR-M665	6859T	6859		6859S
	SLX BR-M666, 675, 7000, 7100	6894T	6894	6894MC	6894S
	SLX BR-M7120	6891T	6891	6891MC	6891S
	Sora BR-R315, 317	6894T	6894	6894MC	6894S
	Tiagra BR-4770, BR-RS405	6907T	6907	6907MC	6907S
	Tourney TX BR-TX805	6854T	6854	6854MC	6854S
	Ultegra BR-CX77	6894T	6894	6894MC	6894S
	Ultegra BR-R8070, 8170, BR-RS805	6907T	6907	6907MC	6907S
	XTR BR-M9000, 9020, 985, 987	6894T	6894	6894MC	6894S
	XTR BR-M9100, 9110	6907T	6907	6907MC	6907S
	XTR BR-M9120	6891T	6891	6891MC	6891S
	XTR BR-M965, 966, 975	6859T	6859		6859S
	ZEE BR-M640	6891T	6891	6891MC	6891S
	SRAM	700 B1 HRD, Apex, CX1, eTap, Force, HRR, Level TLM, Level Ultimate, Red, Rival, S900		6900	6900MC
9.0			6853		
Code, Guide RE			6895	6895MC	6895S
DB5, Level, Level T, Level TL, Force eTap, Rival eTap, RED two-piece caliper		6906T	6906	6906MC	6906S
Suntour	Guide R, Guide RS, Guide RSC, Guide Ultimate		6898	6898MC	6898S
	Via GT, X0, XX, XX World Cup	6890T	6890	6890MC	6890S
	DB XCC-MC		6875		
Tektro	SR1		6879		
	Aquila MD-M500	6854T	6854	6854MC	6854S
	Aries MD-M300	6854T	6854	6854MC	6854S
	Auriga E HD-E500, 520, 525, 530	6854T	6854	6854MC	6854S
	Auriga HD-E515, HD-T515, Auriga E HD-E510		6875		
	Auriga HD-M290, 291 HD-T520, 525, 530, Auriga Pro HD-M700	6854T	6854	6854MC	6854S
	Dorado 4P HD-E720, 725, HD-M745	6891T	6891	6891MC	6891S
	Dorado HD-E710		6905		
	Dorado HD-E715	6854T	6854	6854MC	6854S
	Draco HD-M350, 351, 352	6854T	6854	6854MC	6854S
	Gemini HD-M500, 501, 510, 520, 521	6854T	6854	6854MC	6854S
	HDC HD-M300, 301, 330	6854T	6854	6854MC	6854S
	HD-E350, HD-T275, 280, 285, 386, MD-C510, MD0M280, MD-U510	6854T	6854	6854MC	6854S
	HD-R310, 510	6907T	6907	6907MC	6907S
	IO		6868		
	Junior HD-M282	6854T	6854	6854MC	6854S
	Lyra		6901		
	Mira MD-C400	6854T	6854	6854MC	6854S
	Orion 4+2P (front) HD-M735, Orion 4P HD-M745	6891T	6891	6891MC	6891S
	Orion HD-M720, 730, Orion 4+2P (rear) HD-M735, Orion SL HD-M740	6854T	6854	6854MC	6854S
Vela HD-T290	6854T	6854	6854MC	6854S	
Volans HD-T700		6875			
Volans HD-T710	6854T	6854	6854MC	6854S	
Novela (IOX.11)		6912			
TRP	Dash Sport, HY/RD, Hylex, Hylex RS HD-C801, Parabox R, Slate X2, Spyke, Spyre	6854T	6854	6854MC	6854S
	G-Spec, Quadiem, Slate T4, Zurich	6891T	6891	6891MC	6891S
	Hylex HD-C810, Hylex RS HD-C811, HD-T910	6907T	6907	6907MC	6907S
Van Moof	Model S, Model X	6862T	6862	6862MC	6862S
	Zoom		6872	6872MC	

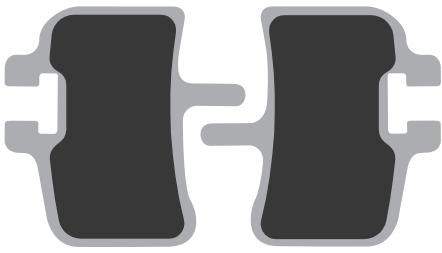

6850 - CARD
6850 S - CARD

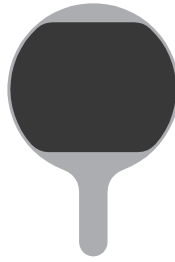

6851 - CARD

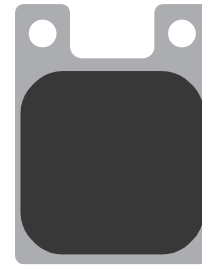

6852 - CARD

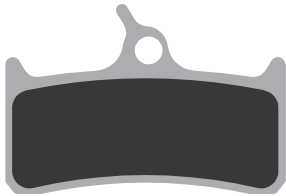

6853 - CARD

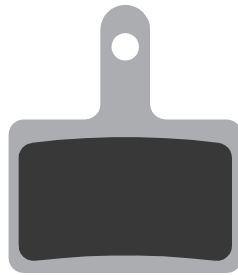

6854 T - CARD / -BOX / -BOX25
6854 - CARD / -BOX / -BOX25
6854 MC - CARD / -BOX / -BOX25
6854 S - CARD / -BOX / -BOX25

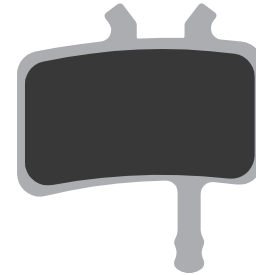

6855 - CARD
6855 MC - CARD
6855 S - CARD

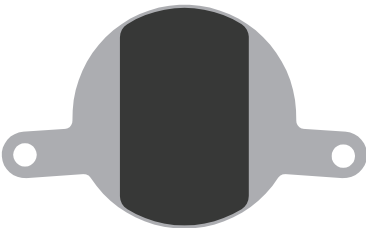

6856 - CARD



6857 - CARD

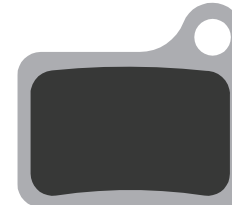

6858 - CARD



6859 T - CARD
6859 - CARD
6859 S - CARD



6860 - CARD



6861 - CARD

BRAKE

- DISC BRAKE SYSTEMS
- CALIPER ADAPTERS
- CALIPER BOLTS
- DISC BRAKE ROTORS
- DISC BRAKE PARTS

DISC BRAKE PADS

- RIM BRAKE PADS

CABLE

- INNER CABLES
- SUPERFLEX
- OUTER CABLES
- CABLE KITS
- CABLE PARTS

HYDRO

- ORIGINAL BRANDS
- HYDRO COMPONENTS
- SHIMANO HYDRO COMPONENTS
- O-RINGS

ROTATION

- BEARINGS
- HEADSET BEARINGS
- HEADSET PARTS
- PULLEY WHEELS
- BOTTOM BRACKET GUIDE
- BOTTOM BRACKETS
- BOTTOM BRACKET PARTS

TOOLS AND MAINTENANCE

- MAINTENANCE
- CABLE TOOLS
- HYDRO TOOLS
- MORE TOOLS
- BOTTOM BRACKET TOOLS

WORKSHOP

- TRANSIT
- BOXER
- PARTNER
- CADDY
- PADFINDER
- DISCOVERY
- BLEED STATION

DISC BRAKE PADS

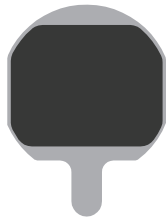

6862 T - CARD
6862 - CARD
6862 MC - CARD



6863 - CARD
6863 S - CARD



6864 - CARD



6865 - CARD

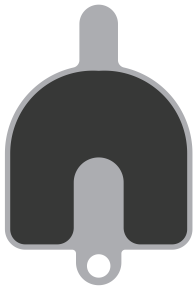

6866 - CARD



6867 - CARD

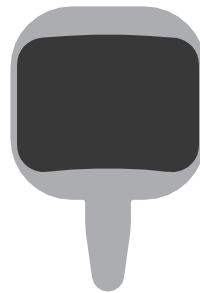

6868 - CARD



6869 - CARD

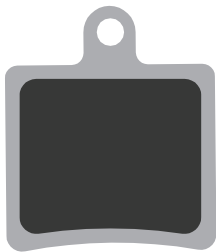

6870 - CARD

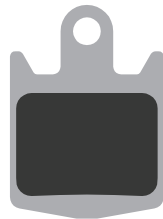

6871 - CARD



6872 - CARD
6872 MC - CARD

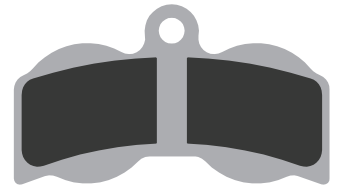

6873 - CARD



6874 - CARD

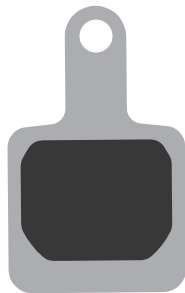

6875 - CARD

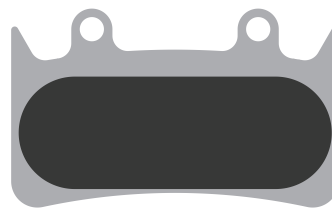

6876 - CARD

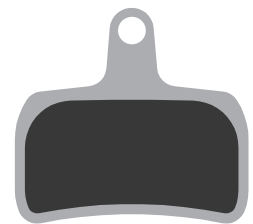

6877 - CARD

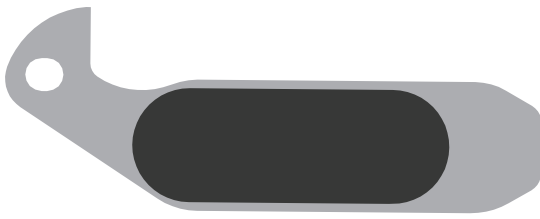

6878 - CARD

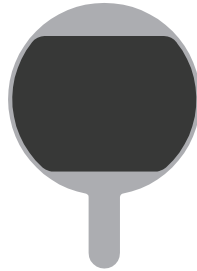

6879 - CARD

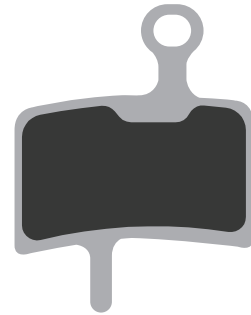

6880 - CARD

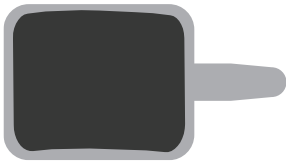

6881 - CARD

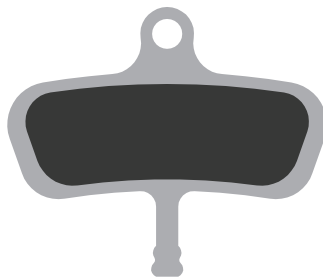

6882 - CARD

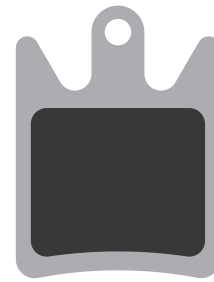

6883 - CARD



6884 - CARD
6884 S - CARD



6885 - CARD

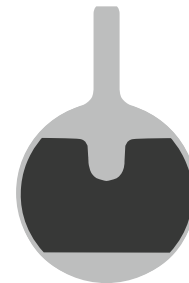

6886 - CARD
6886 MC - CARD

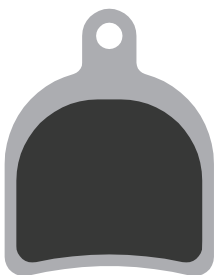

6887 - CARD

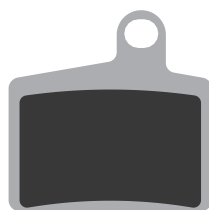

6888 - CARD
6888S

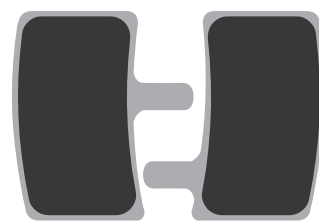

6889 - CARD
6889S

BRAKE

- DISC BRAKE SYSTEMS
- CALIPER ADAPTERS
- CALIPER BOLTS
- DISC BRAKE ROTORS
- DISC BRAKE PARTS

DISC BRAKE PADS

- RIM BRAKE PADS

CABLE

- INNER CABLES
- SUPERFLEX
- OUTER CABLES
- CABLE KITS
- CABLE PARTS

HYDRO

- ORIGINAL BRANDS
- HYDRO COMPONENTS
- SHIMANO HYDRO COMPONENTS
- O-RINGS

ROTATION

- BEARINGS
- HEADSET BEARINGS
- HEADSET PARTS
- PULLEY WHEELS
- BOTTOM BRACKET GUIDE
- BOTTOM BRACKETS
- BOTTOM BRACKET PARTS

TOOLS AND MAINTENANCE

- MAINTENANCE
- CABLE TOOLS
- HYDRO TOOLS
- MORE TOOLS
- BOTTOM BRACKET TOOLS

WORKSHOP

- TRANSIT
- BOXER
- PARTNER
- CADDY
- PADFINDER
- DISCOVERY
- BLEED STATION

DISC BRAKE PADS

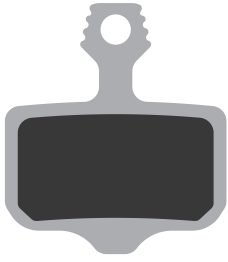

6890 T - CARD / -BOX
 6890 - CARD / -BOX
 6890 MC - CARD / -BOX
 6890 S - CARD / -BOX

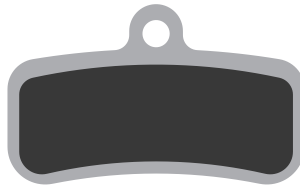

6891 T - CARD
 6891 - CARD
 6891 MC - CARD
 6891 S - CARD

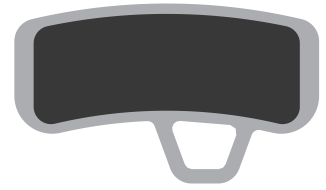

6892 - CARD

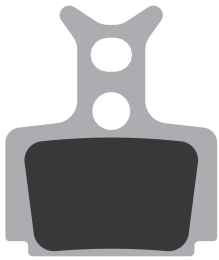

6893 - CARD
 6893 MC - CARD
 6893 S - CARD

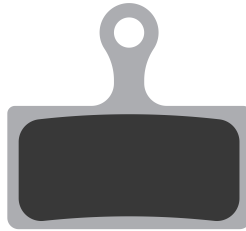

6894 T - CARD / -BOX
 6894 - CARD / -BOX / -BOX25
 6894 MC - CARD / -BOX / -BOX25
 6894 S - CARD / -BOX / -BOX25

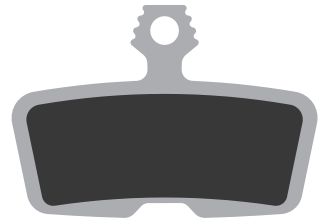

6895 - CARD
 6895 MC - CARD
 6895 S - CARD

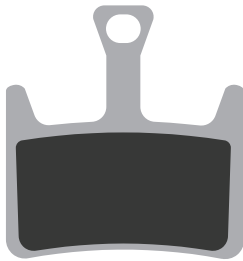

6896 - CARD
 6896 S - CARD

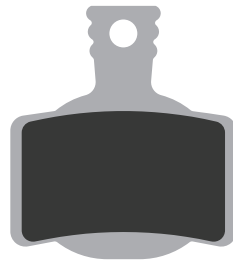

6897 T - CARD / -BOX
 6897 - CARD / -BOX
 6897 MC - CARD / -BOX
 6897 S - CARD / -BOX



6898 - CARD / -BOX
 6898 MC - CARD / -BOX
 6898 S - CARD / -BOX

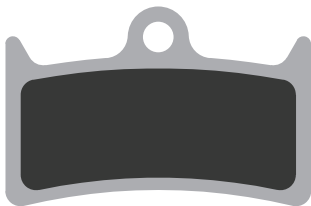

6899 - CARD
 6899 S - CARD

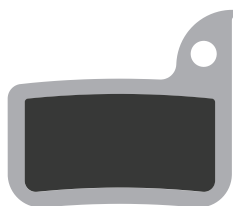

6900 - CARD / -BOX / -BOX25
 6900 MC - CARD / -BOX / -BOX25
 6900 S - CARD / -BOX / -BOX25

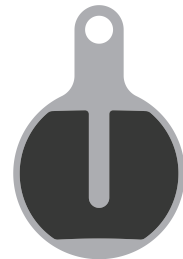

6901 - CARD

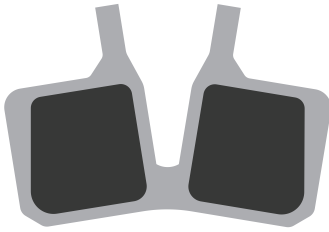

6902 T - CARD
 6902 - CARD / -BOX / -BOX25
 6902 MC - CARD / -BOX / -BOX25
 6902 S - CARD / -BOX / -BOX25

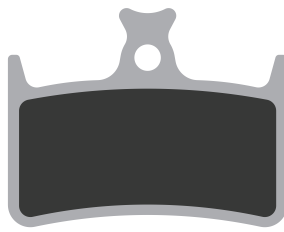

6903 - CARD



6904 - CARD



6905 - CARD

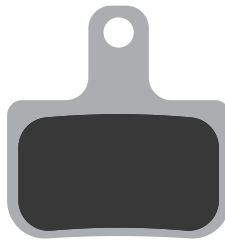

6906 T - CARD
 6906 - CARD / -BOX / -BOX25
 6906 MC - CARD / -BOX / -BOX25
 6906 S - CARD / -BOX / -BOX25

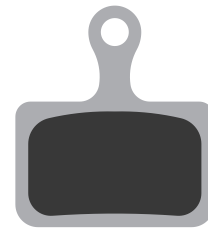

6907 T - CARD / -BOX
 6907 - CARD / -BOX / -BOX25
 6907 MC - CARD / -BOX
 6907 S - CARD

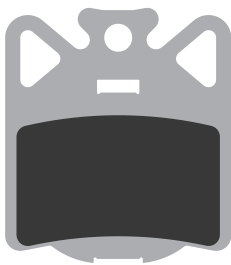

6908T - CARD

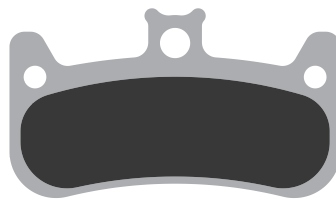

6909 - CARD
 6909 MC - CARD
 6909 S - CARD

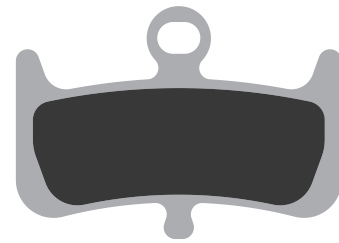

6910 - CARD
 6910 MC - CARD
 6910 S - CARD

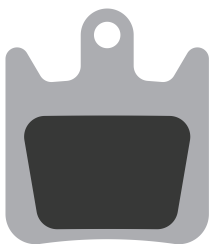

6911 - CARD
 6911 MC - CARD
 6911 S - CARD

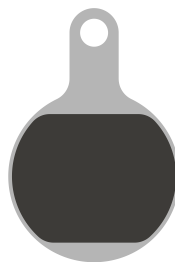

6912 - CARD

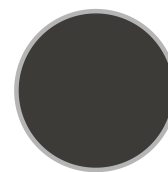

6913 - CARD

BRAKE

- DISC BRAKE SYSTEMS
- CALIPER ADAPTERS
- CALIPER BOLTS
- DISC BRAKE ROTORS
- DISC BRAKE PARTS

DISC BRAKE PADS

- RIM BRAKE PADS

CABLE

- INNER CABLES
- SUPERFLEX
- OUTER CABLES
- CABLE KITS
- CABLE PARTS

HYDRO

- ORIGINAL BRANDS
- HYDRO COMPONENTS
- SHIMANO HYDRO COMPONENTS
- O-RINGS

ROTATION

- BEARINGS
- HEADSET BEARINGS
- HEADSET PARTS
- PULLEY WHEELS
- BOTTOM BRACKET GUIDE
- BOTTOM BRACKETS
- BOTTOM BRACKET PARTS

TOOLS AND MAINTENANCE

- MAINTENANCE
- CABLE TOOLS
- HYDRO TOOLS
- MORE TOOLS
- BOTTOM BRACKET TOOLS

WORKSHOP

- TRANSIT
- BOXER
- PARTNER
- CADDY
- PADFINDER
- DISCOVERY
- BLEED STATION

RIM BRAKE PAD GUIDE

☀ BLACK COMPOUND

- For steel and aluminium rims
- Developed for dry conditions
- Excellent for city bike / trekking bike / racing bike



☁ BLACK/RED COMPOUND

- For steel and aluminium rims
- Developed for wet conditions
- Excellent for MTB



WHITE COMPOUND

This brake pad is specially developed for comfortable, powerful braking. Its unique white compound is silent and doesn't contaminate the rims with black residue.

☀☁🔊 WHITE COMPOUND

- For steel and aluminium rims
- For more brake power
- For less noise
- Developed for dry and wet conditions
- Excellent for E-bike / racing bike / BMX



☀☁ BLUE COMPOUND

- For carbon rims only
- Developed for dry and wet conditions
- Excellent for racing bike / BMX



How to replace
V-brake pads

ORDER QUANTITY

XXXX -CARD

All rim brake pads can be ordered per card, containing 1 pair.

XXXX -BOX

Select rim brake pads can be ordered per box, containing 25 pairs.

Fits Caddy display (page 78)

XXXX-BAG100

Select rim brake pads can be ordered in a bulk bag, containing 100 pairs.



6813

-CARD
Caliper
X-groove design



+ 6843

-CARD
Caliper
X-groove design
More brake power
Less noise



6814

-CARD / -BOX / -BAG100
Power pads
compatible with
Magura HS11/33



+ 6840

-CARD / -BOX / -BAG100
Power pads
compatible with
Magura HS11/33
More brake power
Less noise



6846

-CARD
Race
compatible with
Campagnolo
55 mm cartridge



+ 6836

-CARD
Race
compatible with
Campagnolo
55 mm light weight cartridge
More brake power
Less noise



6844

-CARD
Race
compatible with
Campagnolo
55 mm light weight
cartridge
For carbon rims only



6822

-CARD
Race
compatible with
Campagnolo
55 mm replacement pad for
6836, 6844, 6846



+ 6838

-CARD
Race
compatible with
Campagnolo
More brake power
Less noise
55 mm replacement pad for
6836, 6844, 6846



6826

-CARD
Race
compatible with
Campagnolo
55 mm replacement pad for
6836, 6844, 6846



BRAKE

DISC BRAKE SYSTEMS
CALIPER ADAPTERS
CALIPER BOLTS
DISC BRAKE ROTORS
DISC BRAKE PARTS
DISC BRAKE PADS

RIM BRAKE PADS

CABLE

INNER CABLES
SUPERFLEX
OUTER CABLES
CABLE KITS
CABLE PARTS

HYDRO

ORIGINAL BRANDS
HYDRO
COMPONENTS
SHIMANO HYDRO
COMPONENTS
O-RINGS

ROTATION

BEARINGS
HEADSET BEARINGS
HEADSET PARTS
PULLEY WHEELS
BOTTOM BRACKET
GUIDE
BOTTOM BRACKETS
BOTTOM BRACKET
PARTS

TOOLS AND MAINTENANCE

MAINTENANCE
CABLE TOOLS
HYDRO TOOLS
MORE TOOLS
BOTTOM BRACKET
TOOLS

WORKSHOP

TRANSIT
BOXER
PARTNER
CADDY
PADFINDER
DISCOVERY
BLEED STATION

RIM BRAKE PADS

6808

-CARD
Cantilever
70 mm symmetrical



6812

-BOX
Cantilever
72 mm



6833

-CARD
Cantilever
55 mm cartridge
Cyclocross



6834

-CARD
Cantilever
55 mm replacement
pad for 6833
Cyclocross



6842

-CARD / -BOX
Race
compatible with
Shimano
55 mm



+ 6848

-CARD
Race
compatible with
Shimano
55 mm
More brake power
Less noise



6847

-CARD
Race
compatible with
Shimano
55 mm cartridge



+ 6835

-CARD
Race
compatible with
Shimano
55 mm light weight cartridge
More brake power
Less noise



6845

-CARD
Race
compatible with
Shimano
55 mm cartridge



6810

-CARD / -BOX
Race
compatible with
Shimano
55 mm replacement pad for
6833, 6835, 6845, 6847



+ 6837

-CARD
Race
compatible with
Shimano
55 mm replacement pad for
6833, 6835, 6845, 6847
More brake power
Less noise



6827

-CARD
Race
compatible with
Shimano
55 mm replacement pad for
6833, 6835, 6845, 6847
For carbon rims only



6807

-CARD / -BOX
V-brake pads
55 mm replacement pad



6816

-CARD / -BOX / -BAG100
V-brake pads
70 mm symmetrical



6806

-CARD / -BOX / -BAG100
V-brake pads
72 mm



6828

-BOX
V-brake pads
72 mm
ABS design



6815

-CARD / -BOX
V-brake pads
72 mm
Special groove design



+ 6832

-CARD / -BOX
V-brake pads
72 mm
More brake power
Less noise



6804

-CARD
V-brake pads
72 mm cartridge



6802

-CARD
V-brake pads
72 mm cartridge
Special groove design



6805

-CARD / -BOX
V-brake pads
72 mm replacement pad
for 6802, 6804



6803

-CARD
V-brake pads
72 mm replacement pad
for 6802, 6804
Special groove design



+ 6841

-CARD
V-brake pads
72 mm replacement pad
for 6802, 6804
More brake power
Less noise



6839

-CARD
V-brake pads
72 mm replacement pad
for 6802, 6804
For carbon rims only



BRAKE

DISC BRAKE SYSTEMS
CALIPER ADAPTERS
CALIPER BOLTS
DISC BRAKE ROTORS
DISC BRAKE PARTS
DISC BRAKE PADS

RIM BRAKE PADS

CABLE

INNER CABLES
SUPERFLEX
OUTER CABLES
CABLE KITS
CABLE PARTS

HYDRO

ORIGINAL BRANDS
HYDRO COMPONENTS
SHIMANO HYDRO COMPONENTS
O-RINGS

ROTATION

BEARINGS
HEADSET BEARINGS
HEADSET PARTS
PULLEY WHEELS
BOTTOM BRACKET GUIDE
BOTTOM BRACKETS
BOTTOM BRACKET PARTS

TOOLS AND MAINTENANCE

MAINTENANCE
CABLE TOOLS
HYDRO TOOLS
MORE TOOLS
BOTTOM BRACKET TOOLS

WORKSHOP

TRANSIT
BOXER
PARTNER
CADDY
PADFINDER
DISCOVERY
BLEED STATION

CABLE



VOLUME BOX

G - Galvanised
S - Stainless steel

Fits Boxer display (page 76)



VOLUME BOX

The easy pull system ensures the inner cables can be easily taken out of the box without getting tangled.



19 strands
Regular



19 strands slick
Extra smooth

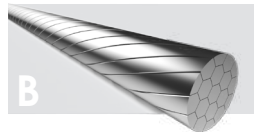

49 (7x7) strands
Extra flexible

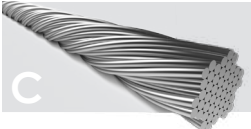

49 (7x7) strands slick
Extra flexible, extra smooth



31 strands slick
Medium flexible, extra smooth

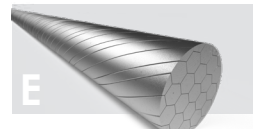

INNER CABLES

Flexible, extra smooth inner cables (D,E) are ideal for easily running through an outer cable with a lot of bends.

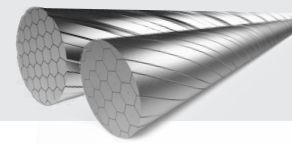

BRAKE

6426RVS-BOX	S	2 000 mm	A	100 pcs
6426RVS-SLICK-BOX	S	2 000 mm	B	100 pcs
6427RVS-BOX	S	2 250 mm	A	100 pcs
6427RVS-SLICK-BOX	S	2 250 mm	B	100 pcs
6427RVS-49-BOX	S	2 250 mm	C	100 pcs
6427RVS-3M-BOX	S	3 000 mm	A	50 pcs

BRAKE

6411RVS-BOX	S	2 000 mm	A	100 pcs
6411RVS-SLICK-BOX	S	2 000 mm	B	100 pcs
6411RVS-49-BOX	S	2 000 mm	C	100 pcs

SHIFT

6472RVS-BOX	S	2 250 mm	A	100 pcs
6472RVS-SLICK-BOX	S	2 250 mm	B	100 pcs
6472RVS-49-BOX	S	2 250 mm	C	100 pcs
+ 6472RVS-49-SLICK-BOX	S	2 250 mm	D	50 pcs
6472RVS-3M-BOX	S	3 000 mm	A	50 pcs

SHIFT

Only compatible with Shimano and SRAM

6472RVS-SHIM-BOX	S	2 250 mm	A	100 pcs
6472RVS-SHIM-SL-BOX	S	2 250 mm	B	100 pcs
+ 6472RVS-SH-49-SL-BOX	S	2 250 mm	D	50 pcs
+ 2021056-BOX	S	2 250 mm	E	50 pcs

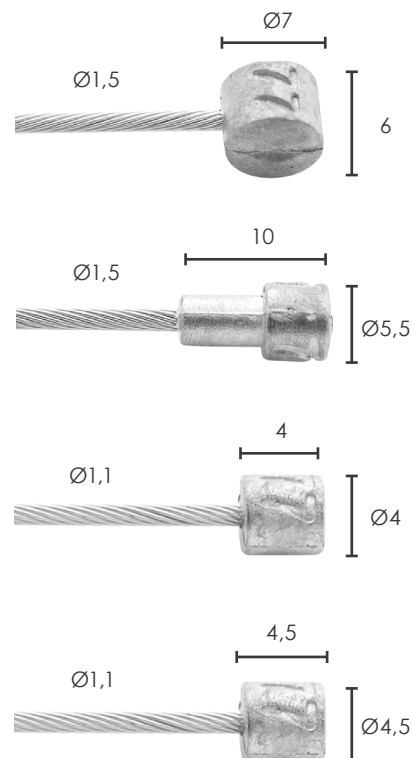

BRAKE

DISC BRAKE SYSTEMS
CALIPER ADAPTERS
CALIPER BOLTS
DISC BRAKE ROTORS
DISC BRAKE PARTS
DISC BRAKE PADS
RIM BRAKE PADS

CABLE

INNER CABLES

SUPERFLEX
OUTER CABLES
CABLE KITS
CABLE PARTS

HYDRO

ORIGINAL BRANDS
HYDRO COMPONENTS
SHIMANO HYDRO COMPONENTS
O-RINGS

ROTATION

BEARINGS
HEADSET BEARINGS
HEADSET PARTS
PULLEY WHEELS
BOTTOM BRACKET GUIDE
BOTTOM BRACKETS
BOTTOM BRACKET PARTS

TOOLS AND MAINTENANCE

MAINTENANCE
CABLE TOOLS
HYDRO TOOLS
MORE TOOLS
BOTTOM BRACKET TOOLS

WORKSHOP

TRANSIT
BOXER
PARTNER
CADDY
PADFINDER
DISCOVERY
BLEED STATION

CARD

Types of inner cables

- G - Galvanised
- S - Stainless steel

19 strands
Regular



19 strands slick
Extra smooth

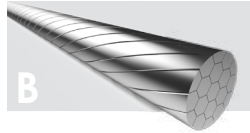

49 (7x7) strands
Extra flexible

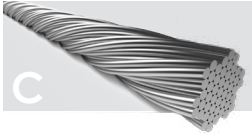

49 (7x7) strands slick
Extra flexible, extra smooth



31 strands slick
Medium flexible, extra smooth

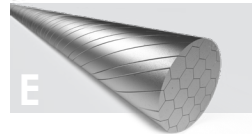

INNER CABLES

Flexible, extra smooth inner cables (D,E) are ideal for easily running through an outer cable with a lot of bends.

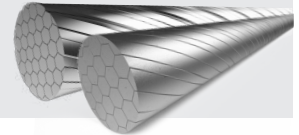

BRAKE

6414	G	900 mm	A	20 pcs
6414RVS	S	1 000 mm	A	20 pcs
6416	G	1 250 mm	A	20 pcs
6416RVS	S	1 250 mm	A	20 pcs
6426	G	2 000 mm	A	20 pcs
6426RVS	S	2 000 mm	A	20 pcs
6426RVS-SLICK	S	2 000 mm	B	20 pcs
6427	G	2 250 mm	A	20 pcs
6427RVS	S	2 250 mm	A	20 pcs
6427RVS-SLICK	S	2 250 mm	B	20 pcs
6427RVS-49	S	2 250 mm	C	20 pcs
6427-3M	G	3 000 mm	A	15 pcs
6427RVS-3M	S	3 000 mm	A	15 pcs
6427RVS-5M	S	5 000 mm	A	10 pcs

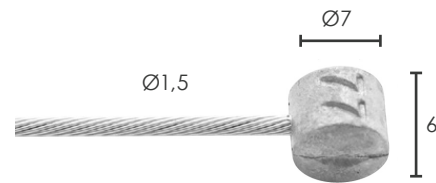

BRAKE

6412/27	G	2 250 mm	A	20 pcs
6412/27RVS	S	2 350 mm	A	20 pcs
6412/27RVS-SLICK	S	2 350 mm	B	20 pcs
6412/27RVS-49	S	2 250 mm	C	20 pcs
6412/27RVS-3M	S	3 000 mm	A	15 pcs
6412/27-4M	G	4 000 mm	A	10 pcs
6412/27RVS-4M	S	4 000 mm	A	10 pcs

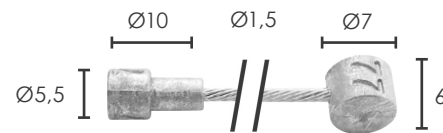

BRAKE

6411	G	2 000 mm	A	20 pcs
6411RVS	S	2 000 mm	A	20 pcs
6411RVS-SLICK	S	2 000 mm	B	20 pcs
6412	G	2 250 mm	A	20 pcs
6412RVS	S	2 250 mm	A	20 pcs
6412RVS-SLICK	S	2 250 mm	B	20 pcs
6412-49	G	2 250 mm	C	20 pcs
6412RVS-49	S	2 250 mm	C	20 pcs

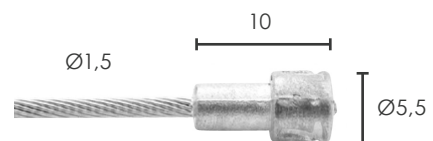

CANTILEVER

2020105 G 400 mm D 20 pcs/carton

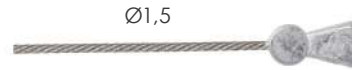

SHIFT

Only compatible with Shimano and SRAM

6472RVS-SHIM S 2 250 mm A 20 pcs/carton

6472RVS-SHIM-SLICK S 2 250 mm B 20 pcs/carton

+ 6472RVS-SHIM-49-SL S 2 250 mm D 20 pcs/carton

+ 2020213 S 4 000 mm D 15 pcs/carton

+ 2021056 S 2 250 mm E 20 pcs/carton

+ 2021057 S 4 000 mm E 15 pcs/carton

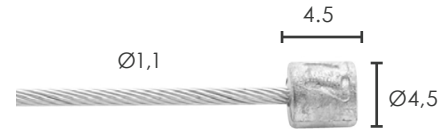

SHIFT

6446 G 2 250 mm A 20 pcs/carton

6446RVS S 2 250 mm A 20 pcs/carton

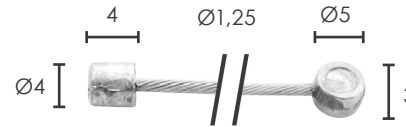

SHIFT

6400 G 2 250 mm A 20 pcs/carton

6400RVS S 2 250 mm A 20 pcs/carton

6400RVS-3M S 3 000 mm A 20 pcs/carton

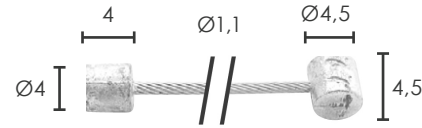

SHIFT

6446-1 G 2 250 mm A 20 pcs/carton

6472RVS S 2 250 mm A 20 pcs/carton

6472RVS-SLICK S 2 250 mm B 20 pcs/carton

6472RVS-3M S 3 000 mm A 20 pcs/carton

6472RVS-49 S 2 250 mm C 20 pcs/carton

+ 6472RVS-49-SLICK S 2 250 mm D 20 pcs/carton

6472RVS-4M S 4 000 mm A 15 pcs/carton

6472RVS-5M S 5 000 mm A 15 pcs/carton



SHIFT

6451/72RVS S 2 250 mm A 20 pcs/carton

6451/72RVS-3M S 3 000 mm A 20 pcs/carton

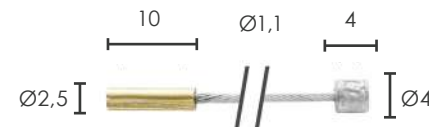

SHIFT

6451/18 G 2 250 mm A 20 pcs/carton

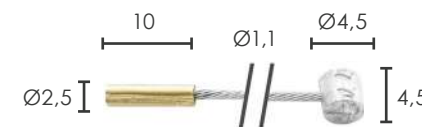

BRAKE

DISC BRAKE SYSTEMS

CALIPER ADAPTERS

CALIPER BOLTS

DISC BRAKE ROTORS

DISC BRAKE PARTS

DISC BRAKE PADS

RIM BRAKE PADS

CABLE

INNER CABLES

SUPERFLEX

OUTER CABLES

CABLE KITS

CABLE PARTS

HYDRO

ORIGINAL BRANDS

HYDRO

COMPONENTS

SHIMANO HYDRO

COMPONENTS

O-RINGS

ROTATION

BEARINGS

HEADSET BEARINGS

HEADSET PARTS

PULLEY WHEELS

BOTTOM BRACKET

GUIDE

BOTTOM BRACKETS

BOTTOM BRACKET

PARTS

TOOLS AND MAINTENANCE

MAINTENANCE

CABLE TOOLS

HYDRO TOOLS

MORE TOOLS

BOTTOM BRACKET

TOOLS

WORKSHOP

TRANSIT

BOXER

PARTNER

CADDY

PADFINDER

DISCOVERY

BLEED STATION

SUPERFLEX



SUPERFLEX OUTER CABLES

Flexible, small diameter outer cables are ideal for internal cable guiding and easily cornering all kinds of edges. Excellent for dropper-posts and lock-out remotes



VOLUME BOX

Fits Boxer display (page 76)

2022018

Ø3,5mm for dropper / remote

Black

Box 30m

For Ø1,1mm inner cable



2023090-BOX

Ø3,0 mm for internal shifting

Black

Box 30m

For Ø0,9mm inner cable



FERRULES

ELV2021080

Ø3,65 to Ø5,5

Aluminium

50 pcs



ELV2023092

Ø3,15 to Ø5,7

Aluminium

50 pcs



SUPERFLEX INNER CABLES

Flexible, extra smooth inner cables (D,E) are ideal for easily running through an outer cable with a lot of bends.

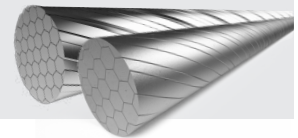

VOLUME BOX

Only compatible with Shimano and SRAM
Fits Boxer display (page 76)

6472RVS-SH-49-SL-BOX S 2 250 mm D 50 pcs

2021056-BOX S 2 250 mm E 50 pcs

2023091-BOX S 2 500mm A 50 pcs

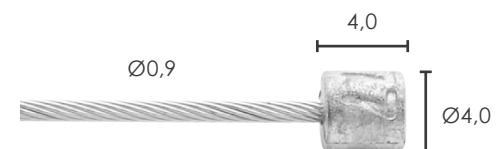
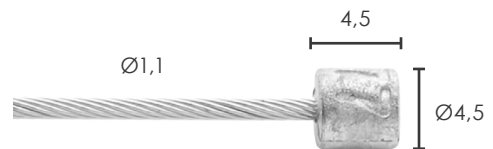

CARD

Only compatible with Shimano and SRAM

6472RVS-SHIM-49-SL S 2 250 mm D 20 pcs/carton

2020213 S 4 000 mm D 15 pcs/carton

2021056 S 2 250 mm E 20 pcs/carton

2021057 S 4 000 mm E 15 pcs/carton

SHIFT OT-RS900

2021074	240 mm	Black	10 pcs/bag, 15 bags/carton
2021073	240 mm	Black	1 pce/bag, 15 bags/carton



CABLE KIT DROPPER-POST AND LOCK-OUT REMOTES (excl. remote)

2021081

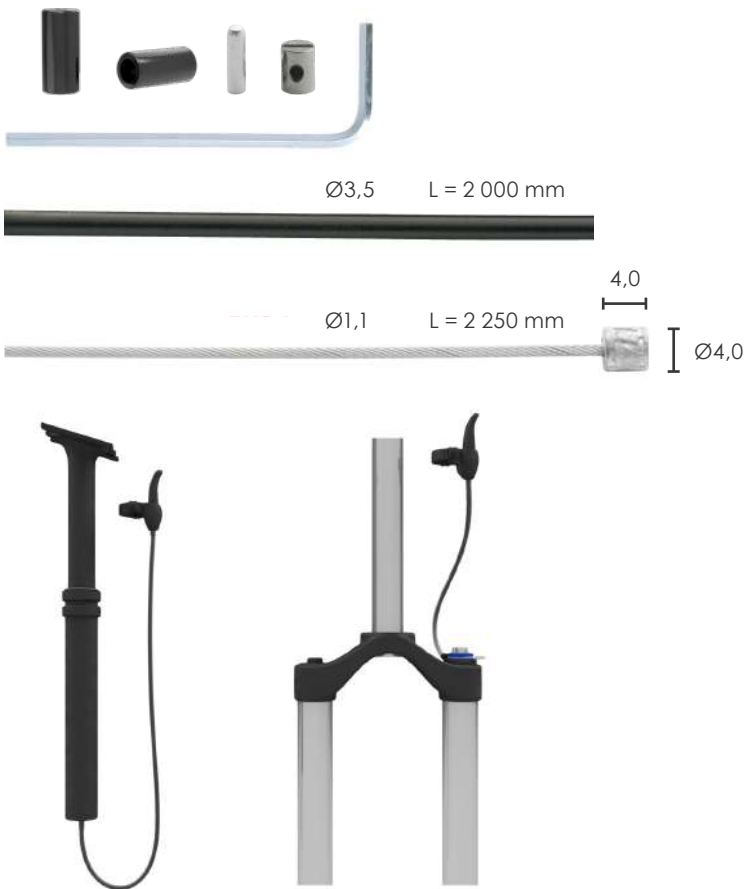

CABLE KIT MICRO FLEX FOR 1X SHIFT (excl. remote)

2023089



Brake cable

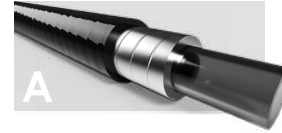

Brake cable



49 (7x7) strands slick
Extra flexible, extra smooth



Shift cable



19 strands regular



BRAKE

- DISC BRAKE SYSTEMS
- CALIPER ADAPTERS
- CALIPER BOLTS
- DISC BRAKE ROTORS
- DISC BRAKE PARTS
- DISC BRAKE PADS
- RIM BRAKE PADS

CABLE

INNER CABLES

SUPERFLEX

- OUTER CABLES
- CABLE KITS
- CABLE PARTS

HYDRO

- ORIGINAL BRANDS
- HYDRO COMPONENTS
- SHIMANO HYDRO COMPONENTS
- O-RINGS

ROTATION

- BEARINGS
- HEADSET BEARINGS
- HEADSET PARTS
- PULLEY WHEELS
- BOTTOM BRACKET GUIDE
- BOTTOM BRACKETS
- BOTTOM BRACKET PARTS

TOOLS AND MAINTENANCE

- MAINTENANCE
- CABLE TOOLS
- HYDRO TOOLS
- MORE TOOLS
- BOTTOM BRACKET TOOLS

WORKSHOP

- TRANSIT
- BOXER
- PARTNER
- CADDY
- PADFINDER
- DISCOVERY
- BLEED STATION



VOLUME BOX

All Elvedes outer cables have MoS₂ enriched liner for lower friction and higher performance.

The outer cable volume boxes come with an easy pull reel made of 100% recycled and 100% recyclable plastic.

The boxes are also equipped with a unique GripClip, which prevents the outer cable from slipping back into the box after cutting.

Fits Boxer display (page 76)



The cable type is indicated by the letter A, B, C or D

Brake cable

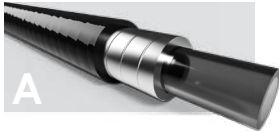

Braided brake cable

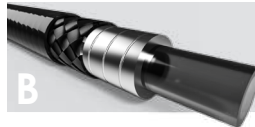

Shift cable



Braided shift / brake cable



SHIFT Ø4,1

Box 30m	Bag 10m	Colour	
1120SP-1-BOX	1120SP-1-10	C	Black
1120SP-3-BOX	1120SP-3-10	C	Silver
1120SP-6-BOX	1120SP-6-10	C	White
1120SP-7-BOX	1120SP-7-10	C	Red
1120SP-8-BOX	1120SP-8-10	C	Blue
1120SP-9-BOX	1120SP-9-10	C	Orange
1120SP-10-BOX	1120SP-10-10	C	Green
1120SP-11-BOX	1120SP-11-10	C	Neon orange
1120SP-12-BOX	1120SP-12-10	C	Neon yellow
1120SP-13-BOX	1120SP-13-10	C	Neon green
1120SP-14-BOX	1120SP-14-10	C	Yellow
1120SP-15-BOX	1120SP-15-10	C	Pink
2019089-BOX	2019089-10	C	Brown
2019091-BOX	2019091-10	C	Celeste
2023001-BOX	2023001-10	D	Black

SHIFT Ø4,9

Box 30m	Bag 10m	Colour	
1125SP-1-BOX	1125SP-1-10	C	Black
1125SP-3-BOX	1125SP-3-10	C	Silver
182041-BOX	182041-10	D	Silver
182042-BOX	182042-10	D	Smoke silver
182043-BOX	182043-10	D	Titanium

BRAKE Ø4,9

Box 30m	Bag 10m	Colour	
1125-BOX	1125-10	-	Black
1125TEF-1-BOX	1125TEF-1-10	A	Black
1125TEF-2-BOX	1125TEF-2-10	A	Grey
1125TEF-3-BOX	1125TEF-3-10	A	Silver
1125TEF-6-BOX	1125TEF-6-10	A	White
1125TEF-7-BOX	1125TEF-7-10	A	Red
1125TEF-8-BOX	1125TEF-8-10	A	Blue
1125TEF-9-BOX	1125TEF-9-10	A	Orange
1125TEF-10-BOX	1125TEF-10-10	A	Green
1125TEF-11-BOX	1125TEF-11-10	A	Neon orange
1125TEF-12-BOX	1125TEF-12-10	A	Neon yellow
1125TEF-13-BOX	1125TEF-13-10	A	Neon green
1125TEF-14-BOX	1125TEF-14-10	A	Yellow
1125TEF-15-BOX	1125TEF-15-10	A	Pink
2019088-BOX	2019088-10	A	Brown
2019090-BOX	2019090-10	A	Celeste
1125LSR-6-BOX	1125LSR-6-10	A	Black/chrome
1125LSR-7-BOX	1125LSR-7-10	A	Chrome
182038-BOX	182038-10	B	Silver
182039-BOX	182039-10	B	Smoke silver
182040-BOX	182040-10	B	Titanium

REINFORCED BRAKE AND SHIFT Ø4,9

Box 30m	Bag 10m	Colour	
2010016-BOX	2010016-10	D	Carbon
2020256-BOX	2020256-10	D	Black



Linear outer cable for powerful braking and precise shifting. Excellent for cargo bikes, tandems and mechanical disc brakes.

CABLE KIT

19 strands regular



49 (7x7) strands slick Extra flexible, extra smooth



BRAKE CABLE KIT

fits MTB and road systems

2015009	A	Black	
2015010	A	Silver	
2015011	A	White	
2015012	A	Red	
2015013	A	Blue	
2015014	A	Orange	
2015015	A	Green	
2017150	A	Pink	
2017152	A	Yellow	

Ø4,9

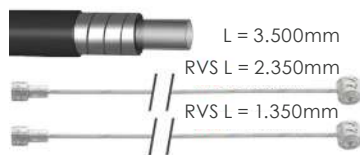

SHIFT CABLE KIT

fits MTB and road systems

2015002	A	Black	
2015003	A	Silver	
2015004	A	White	
2015005	A	Red	
2015006	A	Blue	
2015007	A	Orange	
2015008	A	Green	
2017151	A	Pink	
2017153	A	Yellow	

Ø4,9



Ø4,1



1X SHIFT CABLE KIT

2021040	D	Black	
---------	---	-------	--

FREESTYLE CABLE UPPER

6484 1 pce



FREESTYLE CABLE LOWER

6489 1 pce



BRAKE

- DISC BRAKE SYSTEMS
- CALIPER ADAPTERS
- CALIPER BOLTS
- DISC BRAKE ROTORS
- DISC BRAKE PARTS
- DISC BRAKE PADS
- RIM BRAKE PADS

CABLE

- INNER CABLES
- SUPERFLEX
- OUTER CABLES
- CABLE KITS
- CABLE PARTS

HYDRO

- ORIGINAL BRANDS
- HYDRO COMPONENTS
- SHIMANO HYDRO COMPONENTS
- O-RINGS

ROTATION

- BEARINGS
- HEADSET BEARINGS
- HEADSET PARTS
- PULLEY WHEELS
- BOTTOM BRACKET GUIDE
- BOTTOM BRACKETS
- BOTTOM BRACKET PARTS

TOOLS AND MAINTENANCE

- MAINTENANCE
- CABLE TOOLS
- HYDRO TOOLS
- MORE TOOLS
- BOTTOM BRACKET TOOLS

WORKSHOP

- TRANSIT
- BOXER
- PARTNER
- CADDY
- PADFINDER
- DISCOVERY
- BLEED STATION



UNIVERSAL CABLE SPLITTER SET

Operates 2 brakes with 1 brake lever.
Includes a unique part (D) to add an optional ABS function.

Easy and quick assembly.



Scan this code for instructions

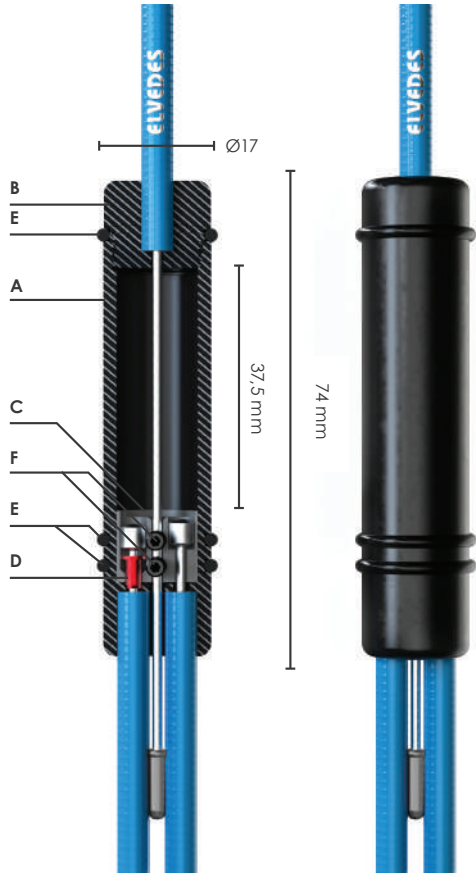

2017161

Inner cables included.
Ø4,9mm outer cables not included.

- | | |
|---------------------|-------------------------|
| A Body | E O-ring |
| B Cap | F M3 fixing bolt |
| C Piston | G Allen key |
| D ABS insert | |

Replacement inner cable (upper)

for universal cable splitter

6412/27RVS/1.35 Stainless 1 350 mm 20 pcs/carton

1x19 strands regular

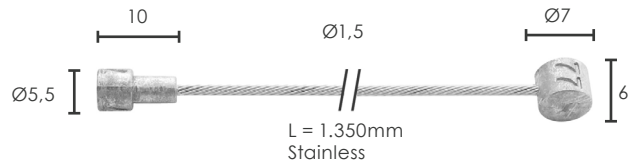

Replacement inner cable (lower)

for universal cable splitter

2017145 Stainless 3 000 mm 15 pcs/carton

49 (7x7) strands
extra flexible

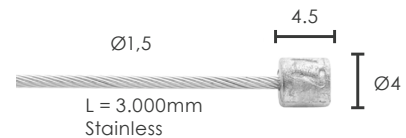
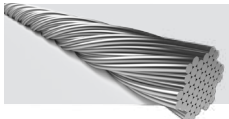

CARD

All cable kits are available per card.
Cards per carton are mentioned per item no.

Types of inner cables

G - Galvanised

S - Stainless steel



BRAKE

- DISC BRAKE SYSTEMS
- CALIPER ADAPTERS
- CALIPER BOLTS
- DISC BRAKE ROTORS
- DISC BRAKE PARTS
- DISC BRAKE PADS
- RIM BRAKE PADS

CABLE

- INNER CABLES
- SUPERFLEX
- OUTER CABLES

CABLE KITS

- CABLE PARTS

HYDRO

- ORIGINAL BRANDS
- HYDRO COMPONENTS
- SHIMANO HYDRO COMPONENTS
- O-RINGS

ROTATION

- BEARINGS
- HEADSET BEARINGS
- HEADSET PARTS
- PULLEY WHEELS
- BOTTOM BRACKET GUIDE
- BOTTOM BRACKETS
- BOTTOM BRACKET PARTS

TOOLS AND MAINTENANCE

- MAINTENANCE
- CABLE TOOLS
- HYDRO TOOLS
- MORE TOOLS
- BOTTOM BRACKET TOOLS

WORKSHOP

- TRANSIT
- BOXER
- PARTNER
- CADDY
- PADFINDER
- DISCOVERY
- BLEED STATION

BRAKE

2021071 1 800 mm Ø4,9 Black 15 pcs/carton



SHIFT

2021072 2 000 mm Ø4,1 Black 15 pcs/carton



DRUMBRAKE

6473 G 2 250 mm 14 pcs/carton

6473RVS S 2 350 mm 14 pcs/carton

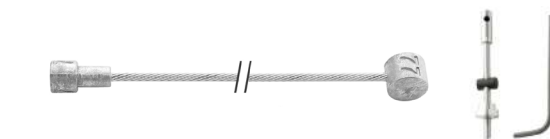

DRUMBRAKE

6269SP G 1 800 mm 2 250 mm Black 15 pcs/carton

6269SP-RVS S 1 800 mm 2 350 mm Black 15 pcs/carton

6269SP-3 S 1 800 mm 2 350 mm Silver 15 pcs/carton



DRUMBRAKE

6268SP G 1 100 mm 1 250 mm Black 15 pcs/carton

6268SP-RVS S 1 100 mm 1 350 mm Black 15 pcs/carton

6268SP-3 S 1 100 mm 1 350 mm Silver 15 pcs/carton



BRAKE UNIVERSAL

6445 G 1 800 mm 2 250 mm Black 15 pcs/carton

6445RVS S 1 800 mm 2 350 mm Black 15 pcs/carton

6445-3 S 1 800 mm 2 350 mm Silver 15 pcs/carton



BRAKE 2 NIPPLES

6444/39 G 1 800 mm 2 250 mm Black 15 pcs/carton

6444/39-RVS S 1 800 mm 2 350 mm Black 15 pcs/carton



BRAKE

6439 G 1 800 mm 2 000 mm Black 15 pcs/carton



BRAKE

6436 G 540 mm 900 mm Black 15 pcs/carton

6436RVS S 540 mm 900 mm Black 15 pcs/carton

6444 G 1 800 mm 2 000 mm Black 15 pcs/carton

6444RVS S 1 800 mm 2 000 mm Black 15 pcs/carton



ROLLERBRAKE BR-IM45/55/80/81/85

2012025 S 1 100 mm 1 250 mm Black 15 pcs/carton

2012026 S 1 100 mm 1 250 mm Silver 15 pcs/carton

2012027 S 1 800 mm 2 250 mm Black 15 pcs/carton

2012028 S 1 800 mm 2 250 mm Silver 15 pcs/carton



ROLLERBRAKE BR-IM41/50/53

6282 S 1 100 mm 1 250 mm Black 15 pcs/carton

6283 S 1 800 mm 2 250 mm Black 15 pcs/carton

6284 S 1 100 mm 1 250 mm Silver 15 pcs/carton

6285 S 1 800 mm 2 250 mm Silver 15 pcs/carton



SHIFT STURMEY ARCHER UNIVERSAL

6478 G 1 800 mm 2 250 mm Black 15 pcs/carton

6478-3 S 1 800 mm 2 250 mm Silver 15 pcs/carton



NEXUS 4/7/8 SPEED

6286 S 2 000 mm 2 250 mm Black 15 pcs/carton

6287 S 2 000 mm 2 250 mm Silver 15 pcs/carton



SHIFT FOR ALL DERAILLEURS + NEXUS 3 SPEED

6479 S 2 000 mm 2 250 mm Black 15 pcs/carton

6479-3 S 2 000 mm 2 250 mm Silver 15 pcs/carton



SHIFT SRAM UNIVERSAL

6477 G 1 800 mm 2 250 mm Black 15 pcs/carton



ASSORTMENT BOX COLOURED FERRULES AND END CAPS 2012020

Contains:
100 aluminium end caps of each colour
25 aluminium ferrules of each size/colour



ALL PARTS AVAILABLE IN CONSUMER AND WORKSHOP PACKAGING

For consumer packaging: CPxxxx
For workshop packaging: ELVxxxx - Fits Partner display (page 77)

ELV2012001 50 pcs
CP2012001 10 pcs
Ferrule with seal
Ø5,0 mm brake
Aluminium



ELV2012007 50 pcs
CP2012007 10 pcs
Ferrule with seal
Ø4,3 mm
Aluminium



ELV1171 500 pcs
CP1171 10 pcs
End cap
Ø2,3 mm
Aluminium



ELV2012002 50 pcs
CP2012002 10 pcs
Ferrule with seal
Ø5,0 mm brake
Aluminium



ELV2012008 50 pcs
CP2012008 10 pcs
Ferrule with seal
Ø4,3 mm
Aluminium



ELV2012013 500 pcs
CP2012013 10 pcs
End cap
Ø2,3 mm
Aluminium



ELV2012004 50 pcs
CP2012004 10 pcs
Ferrule with seal
Ø5,0 mm brake
Aluminium



ELV2012010 50 pcs
CP2012010 10 pcs
Ferrule with seal
Ø4,3 mm
Aluminium



ELV2012015 500 pcs
CP2012015 10 pcs
End cap
Ø2,3 mm
Aluminium



ELV2012003 50 pcs
CP2012003 10 pcs
Ferrule with seal
Ø5,0 mm brake
Aluminium



ELV2012009 50 pcs
CP2012009 10 pcs
Ferrule with seal
Ø4,3 mm
Aluminium



ELV2012014 500 pcs
CP2012014 10 pcs
End cap
Ø2,3 mm
Aluminium



ELV2012006 50 pcs
CP2012006 10 pcs
Ferrule with seal
Ø5,0 mm brake
Aluminium



ELV2012012 50 pcs
CP2012012 10 pcs
Ferrule with seal
Ø4,3 mm
Aluminium



ELV2012017 500 pcs
CP2012017 10 pcs
End cap
Ø2,3 mm
Aluminium



ELV2012005 50 pcs
CP2012005 10 pcs
Ferrule with seal
Ø5,0 mm brake
Aluminium



ELV2012011 50 pcs
CP2012011 10 pcs
Ferrule with seal
Ø4,3 mm
Aluminium



ELV2012016 500 pcs
CP2012016 10 pcs
End cap
Ø2,3 mm
Aluminium



BRAKE

- DISC BRAKE SYSTEMS
- CALIPER ADAPTERS
- CALIPER BOLTS
- DISC BRAKE ROTORS
- DISC BRAKE PARTS
- DISC BRAKE PADS
- RIM BRAKE PADS

CABLE

- INNER CABLES
- SUPERFLEX
- OUTER CABLES

CABLE KITS

CABLE PARTS

HYDRO

- ORIGINAL BRANDS
- HYDRO COMPONENTS
- SHIMANO HYDRO COMPONENTS
- O-RINGS

ROTATION

- BEARINGS
- HEADSET BEARINGS
- HEADSET PARTS
- PULLEY WHEELS
- BOTTOM BRACKET GUIDE
- BOTTOM BRACKETS
- BOTTOM BRACKET PARTS

TOOLS AND MAINTENANCE

- MAINTENANCE
- CABLE TOOLS
- HYDRO TOOLS
- MORE TOOLS
- BOTTOM BRACKET TOOLS

WORKSHOP

- TRANSIT
- BOXER
- PARTNER
- CADDY
- PADFINDER
- DISCOVERY
- BLEED STATION

ELV1172
CP1172
End cap
Ø1,6 mm
Aluminium

500 pcs
10 pcs



ELV2018036
Extension ferrule
Ø4,3 mm
Aluminium

25 pcs



ELV2018035
Extension ferrule
Ø5,0 mm
Aluminium

25 pcs



ELV2023092
Ferrule
Ø3,15 to Ø5,7
Aluminium

50 pcs



ELV2021080
Ferrule
Ø3,65 to Ø5,5
Aluminium

50 pcs



ELV1130
Ferrule S.A.
Ø5,0 mm
Brass

50 pcs



ELV2016108
Ferrule
Ø4,3 to Ø4,75 mm
Brass

150 pcs



ELV2016107
CP2016107
Ferrule
Ø4,3 to Ø5,7 mm
Brass

150 pcs
10 pcs



ELV1001
Ferrule Weinmann
Ø5,5 mm
Aluminium

100 pcs



ELV2015057
Ferrule with seal
Ø4,3 mm
PA6

100 pcs



ELV1160PVC4-1
CP1160PVC4-1
Ferrule
Ø4,3 mm
PA6

150 pcs
10 pcs



ELV1160PVC4-3
Ferrule
Ø4,3 mm
PA6

150 pcs



ELV1161
Ferrule with seal
Ø5,0 mm shift
Brass

100 pcs



ELV1160PVC5-1
CP1160PVC5-1
Ferrule
Ø5,0 mm
PA6

150 pcs
10 pcs



ELV1160PVC5-3
Ferrule
Ø5,0 mm
PA6

150 pcs



ELV1160
CP1160
Ferrule CNC
Ø5,0 mm
Brass

200 pcs
10 pcs



ELV1160PRESSED
Ferrule
Ø5,0 mm
Brass

200 pcs



ELV1167
Ferrule push fit
Ø5,0 mm
Brass

200 pcs



ELV2012107
Ferrule with tip
Ø4,3 mm
PA6

50 pcs



ELV2012106
Ferrule with tip
Ø5 mm
PA6

50 pcs



ELV1178
Open end cap
Ø5,0 mm
Aluminium

25 pcs



ELV2014062
CP2014062

15 pcs
2 pcs

Adjuster inline
Ø4,3 mm
Aluminium



ELV2015173
CP2015173

15 pcs
2 pcs

Adjuster inline
Ø5,0 mm
Aluminium



ELV1073

10 pcs

Adjuster for cable
M6
Brass



ELV1090

25 pcs

Adjuster
M6
Aluminium



ELV1071

15 pcs

Adjuster
M5
Brass



ELV1072

15 pcs

Adjuster
M6
Brass



ELV2020100

15 pcs

Adjuster for lever
M7
Aluminium



ELV2020099

15 pcs

Adjuster for lever
M10
Aluminium



ELV2011003

15 pcs

Adjuster for rollerbrake
M6
Brass



ELV2015139
CP2015139

15 pcs
2 pcs

Adjuster barrel
Ø4,3 mm
Steel



ELV2015140
CP2015140

15 pcs
2 pcs

Adjuster barrel
Ø4,3 mm
Aluminium



CP2019093

2 pcs

Cable guide pipe short
Ø5,0 mm
Aluminium



CP2019094

2 pcs

V-brake pipe 90° adjustable
Ø5,0 mm
Stainless steel



CP2019230

2 pcs

V-brake pipe 90° adjustable, short
Ø5,0 mm
Stainless steel



ELV2018061

10 pcs

V-brake pipe 90° black
Ø5,0 mm
Stainless steel



ELV1162-90

10 pcs

V-brake pipe 90°
Ø5,0 mm
Stainless steel



ELV1162-110

10 pcs

V-brake pipe 110°
Ø5,0 mm
Stainless steel



ELV1162-130

10 pcs

V-brake pipe 130°
Ø5,0 mm
Stainless steel



ELV1162

10 pcs

V-brake pipe flex
Ø5,0 mm
Stainless steel



ELV2012032
CP2012032

10 pcs
1 pce

V-brake pipe flex incl. rubber boot
Ø5,0 mm
Stainless steel



CP2017093

2 pcs

V-brake pipe flex, adjustable
Ø5,0 mm
Aluminium



BRAKE

DISC BRAKE SYSTEMS
CALIPER ADAPTERS
CALIPER BOLTS
DISC BRAKE ROTORS
DISC BRAKE PARTS
DISC BRAKE PADS
RIM BRAKE PADS

CABLE

INNER CABLES
SUPERFLEX
OUTER CABLES
CABLE KITS

CABLE PARTS

HYDRO

ORIGINAL BRANDS
HYDRO COMPONENTS
SHIMANO HYDRO COMPONENTS
O-RINGS

ROTATION

BEARINGS
HEADSET BEARINGS
HEADSET PARTS
PULLEY WHEELS
BOTTOM BRACKET GUIDE
BOTTOM BRACKETS
BOTTOM BRACKET PARTS

TOOLS AND MAINTENANCE

MAINTENANCE
CABLE TOOLS
HYDRO TOOLS
MORE TOOLS
BOTTOM BRACKET TOOLS

WORKSHOP

TRANSIT
BOXER
PARTNER
CADDY
PADFINDER
DISCOVERY
BLEED STATION

ELV2012111 15 pcs
 Rubber boot
 0,8 - 1,2 mm
 Rubber



ELV1163 15 pcs
 Rubber boot for V-brake
 35 mm
 Rubber



ELV2015143 15 pcs
 Rubber boot for V-brake
 35 mm
 Rubber



ELV6482/73 10 pcs
 Linkwire
 73 mm
 Steel



ELV6482/82 10 pcs
 Linkwire
 82 mm
 Steel



ELV6482/93 10 pcs
 Linkwire
 93 mm
 Steel



ELV6482/106 10 pcs
 Linkwire
 106 mm
 Steel



ELV2019095 10 pcs
 Cantilever cable bolt
 Brass



CP2015144 1 pcs
 Cable hanger for cyclo-cross
 Aluminium



ELV2011004 15 pcs
 Cable bolt for Nexus
 4/7/8 speed
 Brass



ELV2011002 15 pcs
 Cable bolt for rollerbrake
 BR-IM41/50/53
 Brass



ELV2012024 15 pcs
 Cable bolt for rollerbrake
 BR-IM85/81/
 80/55/45
 Brass



ELV2012023 25 pcs
 E-cap
 Fits 2012024
 POM



ELV1140 50 pcs
 Cable bolt N-type
 Ø7 × 10 mm
 Brass



ELV1144 50 pcs
 Cable bolt N-type
 Ø8 × 14 mm
 Brass



ELV1141 50 pcs
 Cable bolt T-type
 Ø5 × 7 mm
 Brass



ELV1142 50 pcs
 Cable bolt T-type
 Ø6 × 14 mm
 Brass



ELV1143 25 pcs
 Cable bolt T-type
 Ø8 × 15 mm
 Brass



ELV9009 10 pcs
 Tensioner drumbrake universal
 M4,5
 Brass



ELV4545 15 pcs
 Tensioner S.A. universal
 25 mm
 Brass



ELV5050 10 pcs
 Tensioner SRAM T3
 Ø1,5 mm
 PA-GF



ELV2020102 50 pcs
CP2020102 10 pcs
 Cable clip duo
 4,1 + 4,1 mm
 PA6



ELV2020101 50 pcs
CP2020101 10 pcs
 Cable clip duo
 5,0 + 2,5 mm (Di2)
 PA6



ELV2020103 50 pcs
CP2020103 10 pcs
 Cable clip duo
 5,0 + 4,1 mm
 PA6



ELV2020104 50 pcs
CP2020104 10 pcs
 Cable clip duo
 5,0 + 5,0 mm
 PA6



ELV2015141 50 pcs
CP2015141 4 pcs
 Cable clip rotating
 Ø4,3 - 5,0 mm



ELV2015142 50 pcs
CP2015142 2 pcs
 Cable clip for frame notch
 Ø5,0 mm



ELV1176 25 pcs
 Frame protector
 Ø4,3 - 5,0 mm
 Rubber



ELV2011001 25 pcs
CP2011001 4 pcs
 Frame protector
 Ø4,3 - 5,0 mm
 Rubber



ELV1075 20 pcs
 Cable clip
 Ø5,0 mm
 PP



ELV1174 250 pcs
 O-ring brake/shift
 Ø1,1 - 1,5 mm
 Rubber



SPIRAL WRAP TUBE 10 meter
2018031 Ø4mm bundles 3-8 mm
2018032 Ø6mm bundles 5-10 mm
2018033 Ø12mm bundles 9-65 mm
2018034 Ø15mm bundles 12-70 mm



2018015
ANTI-RATTLE FOAM

Prevents rattling of internal cables and hoses.

Ø11 / 6.0 mm
 L= 750 mm
 10 pcs in sealbag



2016116
 Cable liner
 Ø2,6/2,0mm
 L= 25mtr
 HDPE



CABLE LINER WITH TRUMPET

2018099 Ø2,5/2,0 mm L= 300mm HDPE
2018100 Ø2,5/2,0 mm L= 1 000mm HDPE



2018098 2 pcs
 Inner liner brake
 Ø2,5/2,0mm
 L=1 000mm
 HDPE Liner + ferrule



2018097 2 pcs
 Inner liner shift
 Ø2,0/1,4mm
 L=750mm
 HDPE Liner + ferrule



BRAKE

- DISC BRAKE SYSTEMS
- CALIPER ADAPTERS
- CALIPER BOLTS
- DISC BRAKE ROTORS
- DISC BRAKE PARTS
- DISC BRAKE PADS
- RIM BRAKE PADS

CABLE

- INNER CABLES
- SUPERFLEX
- OUTER CABLES
- CABLE KITS

CABLE PARTS

HYDRO

- ORIGINAL BRANDS
- HYDRO COMPONENTS
- SHIMANO HYDRO COMPONENTS
- O-RINGS

ROTATION

- BEARINGS
- HEADSET BEARINGS
- HEADSET PARTS
- PULLEY WHEELS
- BOTTOM BRACKET GUIDE
- BOTTOM BRACKETS
- BOTTOM BRACKET PARTS

TOOLS AND MAINTENANCE

- MAINTENANCE
- CABLE TOOLS
- HYDRO TOOLS
- MORE TOOLS
- BOTTOM BRACKET TOOLS

WORKSHOP

- TRANSIT
- BOXER
- PARTNER
- CADDY
- PADFINDER
- DISCOVERY
- BLEED STATION

HYDRO





ORIGINAL BRAND HOSE EXTENSION & REPAIR SET

Extend original brand hydro hoses with fitting sets per brand.
Save a lot of time by avoiding internal cable guiding by easily extending your hose to the desired length.

2019101

Shimano
SM-BH59 and SM-BH90



L = 500mm

2019102

Magura



L = 500mm

2019103

SRAM / Avid



L = 500mm

2019104

Tektro 5.5



L = 500mm

2019105

Formula



L = 500mm

2019106

Hayes



L = 500mm

2023123

Tektro 5.0



L = 500mm

ELV2020240

6 pcs extension nipples
12 pcs compression bolts
Fits any original hose
Use with compatible fittings



Scan QR
to learn more

ORIGINAL HOSE VOLUME BOX

Fit corresponding brand parts only
Fit Boxer display (page 76)

2020138	Brake hose for Shimano BH90	20m
2021082	Brake hose for Shimano BH59	20m
2023017	Brake hose for SRAM	20m
2023018	Brake hose for Tektro 5.0	20m
2023019	Brake hose for Magura (not compatible with HS11/33)	20m
2023020	Brake hose for Tektro 5.5	20m



BRAKE

- DISC BRAKE SYSTEMS
- CALIPER ADAPTERS
- CALIPER BOLTS
- DISC BRAKE ROTORS
- DISC BRAKE PARTS
- DISC BRAKE PADS
- RIM BRAKE PADS

CABLE

- INNER CABLES
- SUPERFLEX
- OUTER CABLES
- CABLE KITS
- CABLE PARTS

HYDRO

ORIGINAL BRANDS

- HYDRO COMPONENTS
- SHIMANO HYDRO COMPONENTS
- O-RINGS

ROTATION

- BEARINGS
- HEADSET BEARINGS
- HEADSET PARTS
- PULLEY WHEELS
- BOTTOM BRACKET GUIDE
- BOTTOM BRACKETS
- BOTTOM BRACKET PARTS

TOOLS AND MAINTENANCE

- MAINTENANCE
- CABLE TOOLS
- HYDRO TOOLS
- MORE TOOLS
- BOTTOM BRACKET TOOLS

WORKSHOP

- TRANSIT
- BOXER
- PARTNER
- CADDY
- PADFINDER
- DISCOVERY
- BLEED STATION

ASSORTMENT BOX ORIGINAL BRAND HOSE FITTINGS 2015145

With this box, any original hose of Tektro 5.5, Shimano, Avid, SRAM, Hayes, Formula and Magura can be shortened.
Contains parts to shorten 10 hoses per brand. 60 pieces in total.



ELV-AV01
Compression bolt

Avid
10 pcs



ELV-AV02-1
Olive

Avid
10 pcs



ELV-AV03-1
Insert

Avid
10 pcs



ELV-TK01
Compression bolt

Tektro 5.5
10 pcs



ELV-TK02
Olive

Tektro 5.5
10 pcs



ELV-TK03
Insert

Tektro 5.5
10 pcs



ELV-HY01
Compression bolt

Hayes
10 pcs



ELV-HY02
Insert with olive

Hayes
10 pcs



ELV-HY03
Olive

Hayes
10 pcs



ELV-SH01
Compression bolt

Shimano
10 pcs



ELV-SH02
Olive

Shimano
10 pcs



ELV-SH03
Insert SM-BH59

Shimano
10 pcs



ELV-SH04
Insert SM-BH90

Shimano
10 pcs



ELV-MG01
Compression bolt

Magura
10 pcs



ELV-MG02
Olive

Magura
10 pcs



ELV-MG03
Insert

Magura
10 pcs



ELV-MG04
Compression bolt M9

Magura
10 pcs



ELV-FM01
Compression bolt

Formula
10 pcs



ELV-FM02
Olive

Formula
10 pcs



ELV-FM03
Insert

Formula
10 pcs



ELV-FM04
Compression bolt

Formula
10 pcs



ELV-TK04

Olive
Tektro 5.0
10 pcs



ELV-TK05

Insert
Tektro 5.0
10 pcs



ELV-HP02

Olive

Hope
10 pcs



ELV-HP03

Insert

Hope
10 pcs



ELV-HP04

Washer
(small)

Hope
10 pcs



ELV-HP05

Washer
(large)

Hope
10 pcs



ORIGINAL BRAND HOSE FITTING SET

Shorten 2 original brand hydro hoses with fitting sets per brand. Packed in a sealbag.

CP2019130

Shimano
SM-BH59



CP2019131

Shimano
SM-BH90



CP2019132

Magura



CP2019133

SRAM / Avid



CP2019134

Tektro 5.5



CP2019135

Formula



CP2019136

Hayes



CP2020139

Elvedes



CP2021069

Hope



CP2022105

Tektro 5.0



BRAKE

- DISC BRAKE SYSTEMS
- CALIPER ADAPTERS
- CALIPER BOLTS
- DISC BRAKE ROTORS
- DISC BRAKE PARTS
- DISC BRAKE PADS
- RIM BRAKE PADS

CABLE

- INNER CABLES
- SUPERFLEX
- OUTER CABLES
- CABLE KITS
- CABLE PARTS

HYDRO

ORIGINAL BRANDS

- HYDRO COMPONENTS
- SHIMANO HYDRO COMPONENTS
- O-RINGS

ROTATION

- BEARINGS
- HEADSET BEARINGS
- HEADSET PARTS
- PULLEY WHEELS
- BOTTOM BRACKET GUIDE
- BOTTOM BRACKETS
- BOTTOM BRACKET PARTS

TOOLS AND MAINTENANCE

- MAINTENANCE
- CABLE TOOLS
- HYDRO TOOLS
- MORE TOOLS
- BOTTOM BRACKET TOOLS

WORKSHOP

- TRANSIT
- BOXER
- PARTNER
- CADDY
- PADFINDER
- DISCOVERY
- BLEED STATION

HYDRO HOSE VOLUME BOX

20 meters hose

Fits Elvedes parts only

Fits Boxer display (page 76)

2012030 Black

2012031 White



VOLUME BOX

Elvedes hydro hose is reinforced with a Kevlar housing and has a PTFE liner, which makes it suitable for both mineral oil and DOT fluid. The hydro hose volume boxes come with an easy pull reel made of 100% recycled and 100% recyclable plastic. The boxes are also equipped with a unique GripClip, which prevents the hose from slipping back into the box after cutting.

ASSORTMENT BOX HYDRO PARTS

2012096

Assortment box containing all hydraulic parts and accessories
Fits Elvedes hose only



ELV2017095

Compression bolt
M9 x 1.25
for Magura

Stainless steel

10 pcs



ELV2019115

Banjo bolt

Stainless steel

10 pcs



ELV2012097

Insert
for Elvedes Hydro
Hose only

Brass

30 pcs



ELV2012100

Connector M6

Stainless steel

10 pcs



ELV2012101

Banjo
for Elvedes Hydro
Hose only

Stainless steel

10 pcs



ELV2012104

Banjo bolt

Steel

10 pcs



ELV2012098

Olive

Brass

40 pcs



ELV2012099

Compression bolt
M8 x 0.75

Stainless steel

30 pcs



ELV2012103

Banjo bolt

Stainless steel

10 pcs



ELV2019116

Flange bolt M9
for Shimano

Steel

10 pcs



ELV2012102

Compression nut

Stainless steel

10 pcs



ELV2012105

Washer







Copper

30 pcs



HYDRO HOSE

3 meters hose.
For both front and rear brakes.
Suitable for mineral and DOT oil.
Fits Elvedes parts only

2011006	Black	
2011007	White	
2011008	Red	
2011009	Orange	
2011010	Blue	
2011011	Green	



HYDRO HOSE

Elvedes hydro hose is reinforced with a Kevlar housing and has a PTFE liner, which makes it suitable for both mineral oil and DOT fluid.

HYDRO PARTS KIT

Stainless Steel Parts.
For both front and rear brakes.
Fits Elvedes Hydro hose only

2011012	Kit 1 : M8 + M8
2011013	Kit 2 : M8 + Banjo
2011014	Kit 3 : Banjo + Banjo
2011015	Kit 4 : M8 + M6
2016025	Kit 5 : M8 + Banjo (Shimano)
2016009	Kit 6 : M8 X 1 + Banjo (New Form Mega/R/R1/R1R/Cura)
2016010	Kit 7 : M9 X 1.25 + Banjo (Mag. MT 4/5/5e/6/7/8)
2016011	Kit 8 : M9 X 1.25 + M6 (Mag. MT2)
2019122	Kit 9 : M9 Flange bolt + M8



FIT YOUR KIT

Avid/SRAM

Code, New Code, Juicy 3	Kit 1
All other Juicy, XX 2010-2011	Kit 2
Elixir, XO, XX 2012, Guide	Kit 4

Hayes

Sole, Dyno	Kit 1
All Stroker, all Prime, Trail, Carbon, Ace	Kit 2
Nine HFX-9	Kit 4

Magura

Gustav	Kit 2
Louise, Julie, Marta, New Marta	Kit 4
MT 4 / 5 / 5E / 6 / 7 / 8	Kit 7
MT 2, MT Sport	Kit 8

Elvedes

HP4000	Kit 1
--------	-------

Formula

RX, R1, The One, Mega	Kit 2
Oro	Kit 3
Mega, R, R1, R1R, Cura	Kit 6

Tektro

All Draco, Auriga Comp (WS)	Kit 1
Orion, Volans, all other Auriga	Kit 2

Shimano

MT200, M485, M486, M525, M535, M585, M595, M601, M665 M775, R785, M975	Kit 1
M755, M765, M776, RS785, M640, M800, M810, M988	Kit 2
M965, M966	Kit 3
M666, M675, M785, M985, M7000, M8000	Kit 5
ST-R9170, ST-R8070, ST-RX810, ST-R7070, ST-4770, ST-R400, ST-R9120, ST-R8020	Kit 9

BRAKE

- DISC BRAKE SYSTEMS
- CALIPER ADAPTERS
- CALIPER BOLTS
- DISC BRAKE ROTORS
- DISC BRAKE PARTS
- DISC BRAKE PADS
- RIM BRAKE PADS

CABLE

- INNER CABLES
- SUPERFLEX
- OUTER CABLES
- CABLE KITS
- CABLE PARTS

HYDRO

- ORIGINAL BRANDS

HYDRO COMPONENTS

- SHIMANO HYDRO COMPONENTS
- O-RINGS

ROTATION

- BEARINGS
- HEADSET BEARINGS
- HEADSET PARTS
- PULLEY WHEELS
- BOTTOM BRACKET GUIDE
- BOTTOM BRACKETS
- BOTTOM BRACKET PARTS

TOOLS AND MAINTENANCE

- MAINTENANCE
- CABLE TOOLS
- HYDRO TOOLS
- MORE TOOLS
- BOTTOM BRACKET TOOLS

WORKSHOP

- TRANSIT
- BOXER
- PARTNER
- CADDY
- PADFINDER
- DISCOVERY
- BLEED STATION

REPLACING

+ 2021082

Brake hose for Shimano BH59
With Kevlar and PTFE
20 m



2020106

For BH90



L = 2000mm

2023181



L = 4000mm

+ 2020138

Brake hose for Shimano BH90
With Kevlar and PTFE
20 m



2020107

For BH90



L = 2000mm

2023079



L = 2000mm

REPLACING / SHORTENING

CP2019130

Fitting set BH59



CP2019131

Fitting set

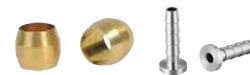

ELV-SH03

Insert BH59
10 pcs



ELV-SH04

Insert BH90
10 pcs



ELV-SH02

Olive
10 pcs



ELV-SH01

Compression bolt
10 pcs



EXTENDING / REPAIRING

2019101

BH59 and BH90



L = 500mm



HOSE EXTENSION & REPAIR SET

Extend Shimano hydro hoses with the hose extension set. Save time by avoiding internal cable guiding by extending your hose to the desired length.

BLEEDING

Mineral oil red

compatible with Shimano DB-OIL

2016005 100 ml
2015169 250 ml
2020238 1 000 ml



Mineral oil syringes

2018040
2 pcs



Bleed adapter set

2020095



Bleed nipple cap

2017186
10 pcs



How to bleed a Shimano brake system

ASSORTMENT BOX O-RINGS

2019240

Replacement o-rings for calipers and master cylinders.
Blue rings for mineral oil
Black rings for DOT oil

Contains 20 pieces of each o-ring



2019241

Shimano R785, XTR
M9000/9020, SLX M7000,
Deore XT M8000/8020,
Alfine S7000

20 pcs



2019242

Shimano Deore, XT, XTR

20 pcs



2019107

Magura MT4/5/6/7/8, Tektro
Orion (SL), Volans, Auriga
(SUB, Tune, Twin), Dorado,
Gemini SL

20 pcs



2019108

Magura MT4

20 pcs



2019109

SRAM Elixir 5, Guide
Ultimate, HydroR for
flatmount

20 pcs



2019110

SRAM Elixir 7/9, XO (Trail),
XX (World Cup), HydroR for
postmount

20 pcs



2019111

SRAM Elixir 7/9, XO (Trail),
XX (World Cup), HydroR for
postmount and Formula R1,
The One, Mega

20 pcs



2019112

SRAM Elixir 5 and Formula
The One

20 pcs



2019113

Formula RX

20 pcs



2019114

Hayes Prime, HFX-9, HFX-
MAG

20 pcs



BRAKE

- DISC BRAKE SYSTEMS
- CALIPER ADAPTERS
- CALIPER BOLTS
- DISC BRAKE ROTORS
- DISC BRAKE PARTS
- DISC BRAKE PADS
- RIM BRAKE PADS

CABLE

- INNER CABLES
- SUPERFLEX
- OUTER CABLES
- CABLE KITS
- CABLE PARTS

HYDRO

- ORIGINAL BRANDS

- HYDRO
COMPONENTS

**SHIMANO HYDRO
COMPONENTS**

O-RINGS

ROTATION

- BEARINGS
- HEADSET BEARINGS
- HEADSET PARTS
- PULLEY WHEELS
- BOTTOM BRACKET
GUIDE
- BOTTOM BRACKETS
- BOTTOM BRACKET
PARTS

TOOLS AND MAINTENANCE

- MAINTENANCE
- CABLE TOOLS
- HYDRO TOOLS
- MORE TOOLS
- BOTTOM BRACKET
TOOLS

WORKSHOP

- TRANSIT
- BOXER
- PARTNER
- CADDY
- PADFINDER
- DISCOVERY
- BLEED STATION



STEEL BEARING BALLS

2021075	1/8"	100 pcs/bag
2021076	5/32"	100 pcs/bag
2021077	3/16"	100 pcs/bag
2021078	1/4"	100 pcs/bag



BEARINGS

All Elvedes bearings are produced complying to ABEC 3.
All Elvedes bearings are provided with extra grease for higher durability and performance.

INDUSTRIAL STEEL BEARINGS

- Balls separated by cage
- For full rotation parts
- ABEC 3



2017103	608 2RS	Ø8 × Ø22 × 7	2017116	6900 2RS	Ø10 × Ø22 × 6
2017104	609 2RS	Ø9 × Ø24 × 7	2017117	6901 2RS	Ø12 × Ø24 × 6
2017105	688 2RS	Ø8 × Ø16 × 5	2017118	6902 2RS	Ø15 × Ø28 × 7
2017106	699 2RS	Ø9 × Ø20 × 6	2017119	6903 2RS	Ø17 × Ø30 × 7
2017107	6000 2RS	Ø10 × Ø26 × 8	2017120	6904 2RS	Ø20 × Ø37 × 9
2017108	6001 2RS	Ø12 × Ø28 × 8	2017121	15267 2RS	Ø15 × Ø26 × 7
2017109	6800 2RS	Ø10 × Ø19 × 5	2017122	17287 2RS	Ø17 × Ø28 × 7
2017110	6801 2RS	Ø12 × Ø21 × 5	2017194	24377 2RS	Ø24 × Ø37 × 7
2017111	6802 2RS	Ø15 × Ø24 × 5	2017195	16100 2RS	Ø10 × Ø28 × 8
2017112	6803 2RS	Ø17 × Ø26 × 5	2018039	18307 2RS	Ø18 × Ø30 × 7
2017113	6804 2RS	Ø20 × Ø32 × 7	2020070	15268 2RS	Ø15 × Ø26 × 8
2017114	6805 2RS	Ø25 × Ø37 × 7	2021051	163110 2RS	Ø16 × Ø31 × 10
2017115	6806 2RS	Ø30 × Ø42 × 7	2023066	16287-2RS	Ø16 × Ø28 × 7

MAX STEEL BEARINGS

- Max amount of balls
- For minimum rotation parts
- For heavy loads
- ABEC 3



2020052	6062RS MAX	Ø6 × Ø17 × 6	2020064	69022RS MAX	Ø15 × Ø28 × 7
2020053	6082RS MAX	Ø8 × Ø22 × 7	2020065	69032RS MAX	Ø17 × Ø30 × 7
2020054	6882RS MAX	Ø8 × Ø16 × 5	2020066	3802W2RS MAX	Ø15 × Ø24 × 10
2020055	6982RS MAX	Ø8 × Ø19 × 6	2020067	3803W2RS MAX	Ø17 × Ø26 × 10
2020056	60002RS MAX	Ø10 × Ø26 × 8	2020068	172862RS MAX	Ø17 × Ø28 × 6
2020057	60012RS MAX	Ø12 × Ø28 × 8	2020069	101972RS MAX	Ø10 × Ø19 × 7
2020058	60032RS MAX	Ø17 × Ø35 × 10	2021018	38022RS MAX	Ø15 × Ø24 × 7
2020059	68002RS MAX	Ø10 × Ø19 × 5	2021019	38032RS MAX	Ø17 × Ø26 × 7
2020060	68022RS MAX	Ø15 × Ø24 × 5	2021049	68032RS MAX	Ø17 × Ø26 × 5
2020061	68052RS MAX	Ø25 × Ø37 × 7	2021050	68062RS MAX	Ø30 × Ø42 × 7
2020062	69002RS MAX	Ø10 × Ø22 × 6	2022026	152672RS MAX	Ø15 × Ø26 × 7
2020063	69012RS MAX	Ø12 × Ø24 × 6			

BEARING GUIDE

INNER DIAMETER	OUTER DIAMETER	WIDTH	TYPE	ITEM NO. INDUSTRIAL BEARING	ITEM NO. MAX BEARING
6	17	6	606		2020052
8	16	5	688	2017105	2020054
8	19	6	698		2020055
8	22	7	608	2017103	2020053
9	20	6	699	2017106	
9	24	7	609	2017104	
10	19	5	6800	2017109	2020059
10	19	7	10197		2020069
10	22	6	6900	2017116	2020062
10	26	8	6000	2017107	2020056
10	28	8	16100	2017195	
12	21	5	6801	2017110	
12	24	6	6901	2017117	2020063
12	28	8	6001	2017108	2020057
15	24	5	6802	2017111	2020060
15	24	7	3802		2021018
15	24	10	3802W		2020066
15	26	7	15267	2017121	2022026
15	26	8	15268	2020070	
15	28	7	6902	2017118	2020064
16	28	7	16287	2023066	
16	31	10	163110	2021051	
17	26	5	6803	2017112	2021049
17	26	7	3803		2021019
17	26	10	3803W		2020067
17	28	6	17286		2020068
17	28	7	17287	2017122	
17	30	7	6903	2017119	2020065
17	35	10	6003		2020058
18	30	7	18307	2018039	
20	32	7	6804	2017113	
20	37	9	6904	2017120	
24	37	7	24377	2017194	
25	37	7	6805	2017114	2020061
30	42	7	6806	2017115	2021050

BRAKE

DISC BRAKE SYSTEMS
CALIPER ADAPTERS
CALIPER BOLTS
DISC BRAKE ROTORS
DISC BRAKE PARTS
DISC BRAKE PADS
RIM BRAKE PADS

CABLE

INNER CABLES
SUPERFLEX
OUTER CABLES
CABLE KITS
CABLE PARTS

HYDRO

ORIGINAL BRANDS
HYDRO COMPONENTS
SHIMANO HYDRO COMPONENTS
O-RINGS

ROTATION

BEARINGS

HEADSET BEARINGS
HEADSET PARTS
PULLEY WHEELS
BOTTOM BRACKET GUIDE
BOTTOM BRACKETS
BOTTOM BRACKET PARTS

TOOLS AND MAINTENANCE

MAINTENANCE
CABLE TOOLS
HYDRO TOOLS
MORE TOOLS
BOTTOM BRACKET TOOLS

WORKSHOP

TRANSIT
BOXER
PARTNER
CADDY
PADFINDER
DISCOVERY
BLEED STATION

ASSORTMENT BOX HEADSET BEARINGS

2019096

Assortment box high precision headset bearings

Contains 2 pcs of:

2017134	2017140	2019049
2017135	2017141	2019050
2017136	2017142	2019051
2017137	2017143	2019052
2017138	2017246	2019053
2017139	2017247	

Contains 10 pcs micro spacers

Refill per piece



2017134

MR170

1½"

45° × 45°

Ø40 × Ø52 × 7



2017135

MR122

1½"

36° × 45°

Ø30,2 × Ø41 × 6,5



2017136

MR043

1¼"

36° × 36°

Ø30,15 × Ø41,5 × 6,5



2017137

MR121

1½"

45° × 45°

Ø30,5 × Ø41,8 × 8



2017138

MR168

1¼"

45° × 45°

Ø34 × Ø46,8 × 7



2017139

MR151

1¾"

45° × 45°

Ø37 × Ø48,9 × 7



2017140

MR127

1½"

36° × 45°

Ø40 × Ø51,8 × 8



2017141

MR019

1½"

36° × 45°

Ø40 × Ø51,8 × 7,5



2017142

MR006

1½"

36° × 36°

Ø40 × Ø51 × 6,5



2017143

MR171

1½"

45° × 45°

Ø40 × Ø52 × 7,5



2017246

1¼"

45° × 45°

Ø34,1 × Ø46 × 7



2017247

1½"

36° × 45°

Ø30,15 × Ø41 × 7



2019049

MR155

1½"

45° × 45°

Ø30,5 × Ø41,8 × 7,5



2019050

MR137

1¾"

45° × 45°

Ø37 × Ø46,9 × 7



2019051

MR136

1½"

45° × 45°

Ø30,15 × Ø41 × 7



2019052

1¼"

45° × 45°

Ø32,8 × Ø41,8 × 6



2019053

1½"

36° × 45°

Ø30,15 × Ø41 × 7,7



2017144

Micro spacer

for 1½"

Ø34,5 mm

0,25 mm



2020048

1 1/8"
45° × 45°
Ø41,8 × Ø30,2 × 6,5



2020049

1 1/2"
45° × 45°
Ø52 × Ø40 × 6,5



2020050

1 3/8"
Ø44 × Ø35 × 5



2020051

1 3/8"
Ø48 × Ø37 × 7



2021124

1"
36° × 45°
Ø38 × Ø27,2 × 6,5



2021130

1 1/8"
45° × 45°
Ø41 × Ø30,15 × 6,5



2022017

1 3/8"
36° × 45°
Ø48,9 × Ø37 × 6,5



2022033

1 1/2"
45° × 45°
Ø52 × Ø42 × 7



2022034

1 1/2"
36° × 45°
Ø52 × Ø40 × 6,5



2022029

1 1/4"
36° × 45°
Ø33 × Ø44 × 6



2022032

1 3/8"
36° × 45°
Ø35 × Ø44 × 5,5



BRAKE

- DISC BRAKE SYSTEMS
- CALIPER ADAPTERS
- CALIPER BOLTS
- DISC BRAKE ROTORS
- DISC BRAKE PARTS
- DISC BRAKE PADS
- RIM BRAKE PADS

CABLE

- INNER CABLES
- SUPERFLEX
- OUTER CABLES
- CABLE KITS
- CABLE PARTS

HYDRO

- ORIGINAL BRANDS
- HYDRO COMPONENTS
- SHIMANO HYDRO COMPONENTS
- O-RINGS

ROTATION

BEARINGS

HEADSET BEARINGS

- HEADSET PARTS
- PULLEY WHEELS
- BOTTOM BRACKET GUIDE
- BOTTOM BRACKETS
- BOTTOM BRACKET PARTS

TOOLS AND MAINTENANCE

- MAINTENANCE
- CABLE TOOLS
- HYDRO TOOLS
- MORE TOOLS
- BOTTOM BRACKET TOOLS

WORKSHOP

- TRANSIT
- BOXER
- PARTNER
- CADDY
- PADFINDER
- DISCOVERY
- BLEED STATION

HEADSET BEARING GUIDE

INNER DIAMETER	OUTER DIAMETER	HEIGHT	INNER ANGLE	OUTER ANGLE	INCH	TYPE	ITEM NO.	
27,2	38	6,5	36°	45°	1"		2021124	
30,15	41	7	45°	45°	1 1/8"		2021130	
		7,7	36°	45°	1 1/8"		2017247	
			45°	45°	1 1/8"		2019051	
30,2	41,5	6,5	36°	36°	1 1/8"	MR043	2017136	
			36°	45°	1 1/8"	MR122	2017135	
			45°	45°	1 1/8"		2020048	
30,5	41,8	7,5	45°	45°	1 1/8"	MR155	2019049	
			8	45°	45°	1 1/8"	MR121	2017137
32,8	44	6	45°	45°	1 1/4"	MR136	2019052	
33			36°	45°	1 1/4"		2022029	
34	46,8	7	45°	45°	1 1/4"	MR168	2017138	
34,1			45°	45°	1 1/4"		2017246	
35	44	5			1 3/8"		2020050	
		5,5	36°	45°	1 3/8"		2022032	
37	46,9	7	45°	45°	1 3/8"	MR137	2019050	
						1 3/8"		2020051
			48			1 3/8"		2022017
37	48,9	6,5	36°	45°	1 3/8"		2022017	
		7	45°	45°	1 3/8"	MR151	2017139	
40	51	6,5	36°	36°	1 1/2"	MR006	2017142	
		7,5	36°	45°	1 1/2"	MR019	2017141	
		8	36°	45°	1 1/2"	MR127	2017140	
	51,8	6,5	45°	45°	1 1/2"		2020049	
			36°	45°	1 1/2"		2022034	
40	52	7	45°	45°	1 1/2"	MR170	2017134	
		7,5	45°	45°	1 1/2"	MR171	2017143	
		7	45°	45°	1 1/2"		2022033	

ASSORTMENT BOX HEADSET PARTS

2020140

Assortment box headset parts

Excludes 2022074 and 2022075



2022074

Fork cone for 1 1/8" to 1 1/2"

36° (silver)

Ø30 mm

1 pce



2022075

Fork cone for 1 1/8" to 1 1/2"

45° (black)

Ø30 mm

1 pce



2020129

Fork cone for 1 1/8"

36° (silver)

Ø30 mm

1 pce



2020130

Fork cone for 1 1/8"

45° (black)

Ø30 mm

1 pce



2020131

Fork cone for 1 1/4"

36° (silver)

Ø33 mm

1 pce



2020132

Fork cone for 1 1/4"

45° (black)

Ø33 mm

1 pce



2020133

Fork cone for 1 1/2"

36° (silver)

Ø39,8 mm

1 pce



2020134

Fork cone for 1 1/2"

45° (black)

Ø39,8 mm

1 pce



2020122

Top cover for 1 1/8"

Ø46 mm

8,2 mm

1 pce



2020123

Top cover for 1 1/8"

Ø50 mm

7,2 mm

1 pce



2020124

Top cover for 1 1/8"

Ø55 mm

7,2 mm

1 pce



2020125

Compression ring for 1 1/8"

36° (silver)

5,8 mm

1 pce



2020126

Compression ring for 1 1/8"

45° (black)

5,8 mm

1 pce



2020127

Compression ring for 1 1/8"

36° (silver)

8,4 mm

1 pce



2020128

Compression ring for 1 1/8"

45° (black)

8,4 mm

1 pce



2017144-10

Micro spacer for 1 1/8"

Ø34,5 mm

0,25 mm

10 pcs



2020136

Spacer for 1 1/8"

Ø34 mm

2 mm

5 pcs



2020117

Top cap assembly
sphere shape

For 1 1/8" metal tube

Incl. bolt, star nut
and rubber sealing cap

1 pce



2020118

Top cap assembly
flat shape

For 1 1/8" metal tube

Incl. bolt and star nut

1 pce



2020119

Compression device
23,5mm

For 1 1/8" carbon tube

Incl. bolt, top cap
and rubber
sealing cap

1 pce



2020120

Compression device
26mm

For 1 1/8" carbon tube

Incl. bolt and top cap

1 pce



2020121

Standard steel star nut

For 1 1/8" metal tube

5 pcs



2020135

Rubber sealing cap

For 5mm socket bolt

10 pcs





PULLEY WHEELS

All pulley wheel bearings are produced complying with ABEC 3 or ABEC 5
All pulley wheel bearings are provided with extra grease for higher durability and performance.

2 × 10 TEETH

CP2017231

1 set
ABEC 3 with extra grease
Stainless sealed bearing

Including spacers compatible with:
A - Shimano 8 speed
B - Shimano 7 speed, Campagnolo 8 speed
C - Campagnolo 9 / 10 speed
D - SRAM (one hole upper pulley) 9.0SL ('98) / 9.0 ('97 - '98) / 7.0 ('97 - '98) / 5.0 ('98 - '99)''



2 × 11 TEETH

CP2017086

1 set
2017086-BOX
10 sets

2017086-BOX25
25 sets

ABEC 3 with extra grease
Stainless sealed bearing

Including spacers compatible with:
A - Shimano 8 / 9 / 10 / 11 speed & 10 speed GRX
B - Shimano 7 speed, Campagnolo 8 speed
C - Campagnolo 9 / 10 speed
D - SRAM 7.0 / 9.0 ('97 - '99)''



2 × 11 TEETH

CP2023086

1 set
ABEC 3 with extra grease
Stainless sealed bearing

Compatible with Shimano 12 speed



11 + 13 TEETH

2022004

1 set
ABEC 5 with extra grease
Stainless sealed bearing

Compatible with:
Shimano 11 speed GRX
RD-RX810-GS
RD-RX812-GS
RD-RX815-GS
RD-RX817-GS



BRAKE

DISC BRAKE SYSTEMS
CALIPER ADAPTERS
CALIPER BOLTS
DISC BRAKE ROTORS
DISC BRAKE PARTS
DISC BRAKE PADS
RIM BRAKE PADS

CABLE

INNER CABLES
SUPERFLEX
OUTER CABLES
CABLE KITS
CABLE PARTS

HYDRO

ORIGINAL BRANDS
HYDRO COMPONENTS
SHIMANO HYDRO COMPONENTS
O-RINGS

ROTATION

BEARINGS
HEADSET BEARINGS

HEADSET PARTS

PULLEY WHEELS

BOTTOM BRACKET GUIDE
BOTTOM BRACKETS
BOTTOM BRACKET PARTS

TOOLS AND MAINTENANCE

MAINTENANCE
CABLE TOOLS
HYDRO TOOLS
MORE TOOLS
BOTTOM BRACKET TOOLS

WORKSHOP

TRANSIT
BOXER
PARTNER
CADDY
PADFINDER
DISCOVERY
BLEED STATION

2 × 11 TEETH

CP2017100

ABEC 5 with extra grease
1 set
Stainless sealed bearing

Compatible with:
Shimano 9 / 10 / 11 speed & 10 speed GRX
SRAM X0 / X9 / X7 9 speed MTB > 2011
SRAM X0 / X9 / X7 10 speed MTB
SRAM Apex / Rival / Force 10 speed road
(bushing included)
Campagnolo 11 speed



2 × 13 TEETH

CP2019103

ABEC 5 with extra grease
1 set
Stainless sealed bearing

Compatible with:
Shimano RD-M9100 / M8100 / M7100



2 × 12 TEETH

CP2017101

ABEC 5 with extra grease
1 set
Narrow / wide
Stainless sealed bearing

Compatible with:
SRAM X01 / XX1 / X1 GX 1×11 speed
SRAM Rival 1 / Force 1 1×11 speed



12 + 14 TEETH

CP2017102

ABEC 5 with extra grease
1 set
Narrow / wide
Stainless sealed bearing

Compatible with:
SRAM Eagle XX1 / X01 / NX / SX / GX 1×12 speed
and 2×11 speed MTB



2 × 12 TEETH

2020097

ABEC 5 with extra grease
1 set
Narrow / wide
Ceramic hybrid bearing

Compatible with:
SRAM Force / Red eTap AXS



12 + 14 TEETH

2020098

ABEC 5 with extra grease
1 set
Narrow / wide
Ceramic hybrid bearing

Upgrade for:
SRAM Force / Red eTap AXS



BOTTOM BRACKET GUIDE

GET STARTED

A bottom bracket shell can be threaded or non-threaded, called thread fit and press fit respectively. It is important to know which type of shell you're working with and what the shell diameter and width are, in order to select a fitting bottom bracket.

The most common thread types in thread fit shells are BSA (English thread), ITA (Italian thread) and T47 (M47×1). A thread type bottom bracket is interlocked directly with the shell. Press fit shells come in various diameters and widths, most commonly PF30 (Ø46mm), BB30 (Ø42mm) and BB86/92 (Ø41mm). Press fit bottom brackets are pressed into the shell using a press-in tool.

Another dimension you need to know in order to select a fitting bottom bracket is the spindle diameter. Different brands and models can vary widely, from Ø30mm to

tapered versions like Praxis (Ø30mm – Ø28mm). Differences between brands can also be as little as a few hundredths of millimeters.

Elvedes offers a basic range of bottom brackets, which can be easily adapted to specific types of spindles such as FSA Mega Exo and SRAM / Truvativ GXP using specific bearing caps or reducer kits.

Knowing all three dimensions, the guide on pages 62 – 64 can be used to select the perfectly fitting bottom bracket.

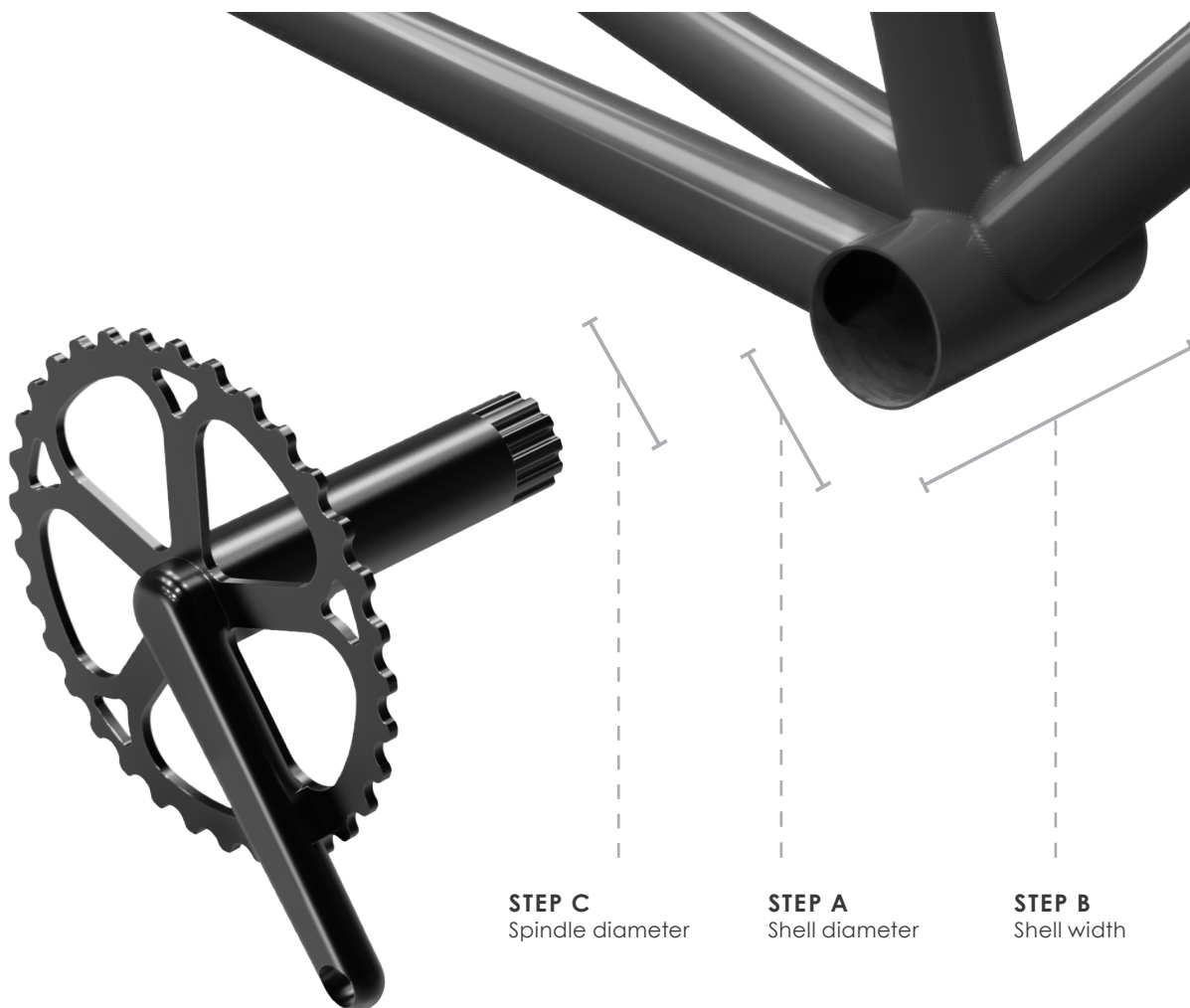

Elvedes also offers an enhanced version of the press fit bottom bracket, called the twist fit bottom bracket (see page 58-60). The twist fit bottom bracket can alternatively be used in a press fit shell. Replacement bearings and bearing caps are also available for maintenance.

BOTTOM BRACKETS

SHIMANO HOLLOWTECH II

Go to:			Page 57			Page 61-63	Page 65	Page 73	Page 63	Page 65
			A	B	C	Item no.	Additionally required	Tool required	Replacement bearing	Replacement bearing cap
Thread fit	BSA	MTB	1,37" × 24 tpi	68 - 73 mm	24 mm	2018066		16T	2019087	2018081
		Road	1,37" × 24 tpi	68 mm	24 mm	2018065		16T	2019087	2018081
		Fatbike	1,37" × 24 tpi	100 mm	24 mm	2019085		16T	2019087	2018081
	ITA	Road	36 mm × 24 tpi	70 mm	24 mm	2018078		16T	2019087	2018081
	T47	External	M47 × 1	68 mm	24 mm	2020093		16T	2019087	2018081
		Internal	M47 × 1	86 mm	24 mm	2020092		16T	2019087	2018081
Press fit	BB86/92		41 mm	86 - 92 mm	24 mm	2018064			2019087	2018082
	BB386		46 mm	86 mm	24 mm	2021079			2019087	2019066
Twist fit	PF30		46 mm	68 - 73 mm	24 mm	2018073		16T	2019087	2018082
	BB30		42 mm							
	BB386		46 mm	86 mm	24 mm	2020084		16T	2019087	2018081
	BB86/92		41 mm	86 - 92 mm	24 mm	2018069		16T	2019087	2018082
		Fatbike	41 mm	106 - 132 mm	24 mm	2019084		16T	2019087	2018082
	BB right	Cervélo	46 mm	79 mm	24 mm	2021065		12T + 16T	2019087	2018082 + 2019066

SRAM / TRUVATIV GXP

Go to:			Page 57			Page 61-63	Page 65	Page 73	Page 63	Page 65
			A	B	C	Item no.	Additionally required	Tool required	Replacement bearing	Replacement bearing cap
Thread fit	BSA	MTB	1,37" × 24 tpi	68 - 73 mm	22 - 24 mm	2018067			2019087	
			1,37" × 24 tpi			2018066	2018080	16T	2019087	2018081
		Road	1,37" × 24 tpi	68 mm	22 - 24 mm	2018065	2018080	16T	2019087	2018081
		Fatbike	1,37" × 24 tpi	100 mm	24 mm	2019085	2018080	16T	2019087	2018081
	ITA	Road	36 mm × 24 tpi	70 mm	22 - 24 mm	2018078	2018080	16T	2019087	2018021
	T47	External	M47 × 1	68 mm	24 mm	2020093	2018080	16T	2019087	2018081
Internal		M47 × 1	86 mm	24 mm	2020092	2018080	16T	2019087	2018081	
Press fit	BB86/92		41 mm	86 - 92 mm	22 - 24 mm	2018064	2018080		2019087	2018082
	BB386		46 mm	86 mm	24 mm	2021079	2018080		2019087	2019066
Twist fit	PF30		46 mm	68 - 73 mm	22 - 24 mm	2018073	2018080	16T	2019087	2018082
	BB30		42 mm						2019087	
	BB386		46 mm	86 mm	22 - 24 mm	2020084	2018080	16T	2019087	2018082
	BB86/92		41 mm	86 - 92 mm	22 - 24 mm	2018069	2018080	16T	2019087	2018082
		Fatbike	41 mm	106-132mm	22 - 24 mm	2019084	2018080	16T	2019087	2018082
	BB right	Cervélo	46 mm	79 mm	24 mm	2021065	2018080	12T + 16T	2019087	2018082 + 2019066

SRAM DUB

Go to:			Page 57			Page 61-63	Page 65	Page 73	Page 63	Page 65
			A	B	C	Item no.	Additionally required	Tool required	Replacement bearing	Replacement bearing cap
Thread fit	BSA	MTB	1,37" × 24 tpi	68 - 73 mm	29 mm	2019118		12T	2018077	
	ITA	Road	36 mm × 24 tpi	70 mm	29 mm	2019119		12T	2018077	
	T47	External	M47 × 1	68 mm	29 mm	2020111		12T	2018077	
		Internal	M47 × 1	86 mm	29 mm	2020112		12T	2018077	
Press fit	BB86/92		41 mm	86 - 92 mm	29 mm	2019117				
Twist fit	PF30		46 mm	68 - 73 mm	29 mm	2019120		12T	2018077	
	BB30		42 mm							
	BB386		46 mm	86 mm	29 mm					

CAMPAGNOLO ULTRA-TORQUE

Go to:			Page 57			Page 61-63	Page 65	Page 73	Page 63	Page 65
			A	B	C	Item no.	Additionally required	Tool required	Replacement bearing	Replacement bearing cap
Twist fit	PF30		46 mm	68 mm	25 mm	2018074			2019086	
	BB386		46 mm	86 mm	25 mm	2020085			2019086	
	BB86		41 mm	86 mm	25 mm	2018070			2019086	

FSA MEGA EXO 24 MM

Go to:			Page 57			Page 61-63	Page 65	Page 73	Page 63	Page 65
			A	B	C	Item no.	Additionally required	Tool required	Replacement bearing	Replacement bearing cap
Thread fit	BSA	MTB	1,37" × 24 tpi	68 - 73 mm	24 mm	2018066	2018083	16T	2019087	2018083
		Road	1,37" × 24 tpi	68 mm	24 mm	2018065	2018083	16T	2019087	2018083
		Fatbike	1,37" × 24 tpi	100 mm	24 mm	2019085	2019067	16T	2019087	2019067
	ITA	Road	36 mm × 24 tpi	70 mm	24 mm	2018078	2018083	16T	2019087	2018083
	T47	External	M47 × 1	68 mm	24 mm	2020093	2018083	16T	2019087	2018083
		Internal	M47 × 1	86 mm	24 mm	2020092	2018083	16T	2019087	2018083
Press fit	BB86/92		41 mm	86 - 92 mm	24 mm	2018064	2018084		2019087	2018084
	BB386		46 mm	86 mm	24 mm	2021079	2019067		2019087	2019067
Twist fit	PF30		46 mm	68 - 73 mm	24 mm	2018073	2018083	16T	2019087	2018083
	BB30		42 mm							
	BB386		46 mm	86 mm	24 mm					
	BB86/92		41 mm	86 - 92 mm	24 mm	2018069	2018084	16T	2019087	2018084
		Fatbike	41 mm	106 - 132 mm	24 mm	2019084	2018084	16T	2019087	2018084
	BB right	Cervélo	46 mm	79 mm	24 mm	2021065	2019067 + 2018084	12T + 16T	2019087	2019067 + 2018084

BOTTOM BRACKETS

FSA MEGA EXO 19 MM

Go to:			Page 57			Page 61-63	Page 65	Page 73	Page 63	Page 65
			A	B	C	Item no.	Additionally required	Tool required	Replacement bearing	Replacement bearing cap
Thread fit	BSA	MTB	1,37" × 24 tpi	68 - 73 mm	19 mm	2018066	2019064	16T	2019087	2019064
		Road	1,37" × 24 tpi	68 mm	19 mm	2018065	2019064	16T	2019087	2019064
	ITA	Road	36 mm × 24 tpi	70 mm	19 mm	2018078	2019064	16T	2019087	2019064
	T47	External	M47 × 1	68 mm	19 mm	2020093	2019064	16T	2019087	2019064
		Internal	M47 × 1	86 mm	19 mm	2020092	2019064	16T	2019087	2019064
Press fit	BB86/92		41 mm	86 - 92 mm	19 mm	2018064	2019065		2019087	2019065
	BB386		46 mm	86 mm	19 mm	2021079	2019064		2019087	2019064
Twist fit	PF30		46 mm	68 - 73 mm	19 mm	2018073	2019064	16T	2019087	2019064
	BB30		42 mm							
	BB386		46 mm	86 mm	19 mm	2020084	2019065	16T	2019087	2019065
	BB86/92		41 mm	86 - 92 mm	19 mm	2018069	2019065	16T	2019087	2019065
		Fatbike	41 mm	106-132mm	19 mm	2019084	2019065	16T	2019087	2019065
	BB right	Cervélo	46 mm	79 mm	19 mm	2021065	2019064 + 2019065	12T + 16T	2019087	2019064 + 2019065

30 MM

Go to:			Page 57			Page 61-63	Page 65	Page 73	Page 63	Page 65
			A	B	C	Item no.	Additionally required	Tool required	Replacement bearing	Replacement bearing cap
Thread fit	BSA	Road	1,37" × 24 tpi	68 mm	30 mm	2018068		12T	2018077	
	ITA	Road	36 mm × 24 tpi	70 mm	30 mm	2018079		12T	2018077	
Press fit	PF30		46 mm	68 mm	30 mm	2019083			2018077	
	BB86/92		41 mm	86 - 92 mm	30 mm	2022085				
Twist fit	PF30	Fatbike	46 mm	100 mm	30 mm	2020086		12T	2018077	
			46 mm	68 - 92 mm	30 mm	2018071		12T	2018077	
	BB386/92							12T		

PRAXIS WORKS M30

Go to:			Page 57			Page 61-63	Page 65	Page 73	Page 63	Page 65
			A	B	C	Item no.	Additionally required	Tool required	Replacement bearing	Replacement bearing cap
Thread fit	BSA	Road	1,37" × 24 tpi	68 mm	28 - 30 mm	2020088		12T	2018077	
	ITA	Road	36 mm × 24 tpi	70 mm	28 - 30 mm	2020089		12T	2018077	
	T47		M47 × 1	68 mm	28 - 30 mm	2020115		12T	2018077	
			M47 × 1	86 mm	28 - 30 mm	2020114		12T	2018077	
Press fit	BB86/92		41 mm	86 - 92 mm	28 - 30 mm	2020087				
Twist fit	PF30		46 mm	68 mm	28 - 30 mm	2020090		12T	2018077	
	BB30		42 mm	68 mm	28 - 30 mm			12T		
	BB386		46 mm	86 mm	28 - 30 mm	2020091		12T	2018077	

THREAD FIT

Tool required: 2018086 Bottom bracket wrench

¹ Convertible to GXP with GXP reducer kit (2018080)

² Convertible to FSA with FSA bearing caps (page 65)

BRAKE

- DISC BRAKE SYSTEMS
- CALIPER ADAPTERS
- CALIPER BOLTS
- DISC BRAKE ROTORS
- DISC BRAKE PARTS
- DISC BRAKE PADS
- RIM BRAKE PADS

CABLE

- INNER CABLES
- SUPERFLEX
- OUTER CABLES
- CABLE KITS
- CABLE PARTS

HYDRO

- ORIGINAL BRANDS
- HYDRO COMPONENTS
- SHIMANO HYDRO COMPONENTS
- O-RINGS

ROTATION

- BEARINGS
- HEADSET BEARINGS
- HEADSET PARTS
- PULLEY WHEELS
- BOTTOM BRACKET GUIDE

BOTTOM BRACKETS

- BOTTOM BRACKET PARTS

TOOLS AND MAINTENANCE

- MAINTENANCE
- CABLE TOOLS
- HYDRO TOOLS
- MORE TOOLS
- BOTTOM BRACKET TOOLS

WORKSHOP

- TRANSIT
- BOXER
- PARTNER
- CADDY
- PADFINDER
- DISCOVERY
- BLEED STATION

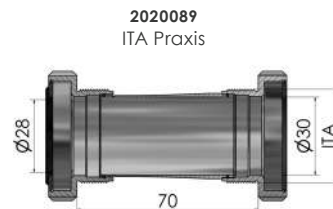
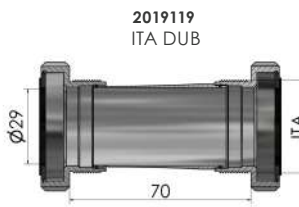
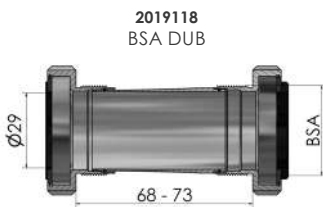
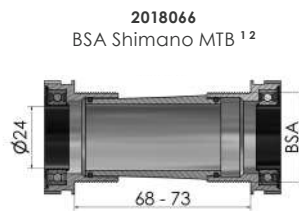

BOTTOM BRACKETS

TWIST FIT

Tools required: 2018086 Bottom bracket wrench

¹ Convertible to GXP with GXP reducer kit (2018080)

² Convertible to FSA with FSA bearing caps (page 65)



LOW MAINTENANCE COSTS

Only the bearings can be replaced for service maintenance, while the bracket stays in place.



PERFECTLY IN LINE

The threaded interlocking cups allow the spindle to run freely without squeaking and creaking.



EASY INSTALLATION

Elvedes BB wrench required (item no. 2018086)

2018069
BB86/92 Shimano ^{1 2}

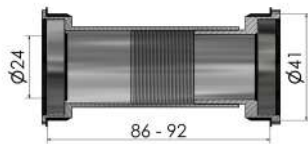

2018070
BB86 UT

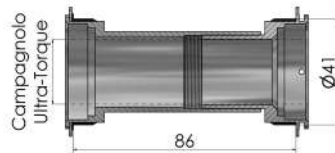

2018071
BB386/92
PF30

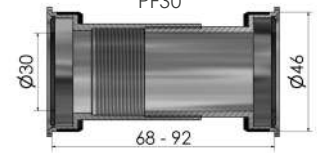

2018073
BB30 Shimano ^{1 2}
PF30 Shimano ^{1 2}

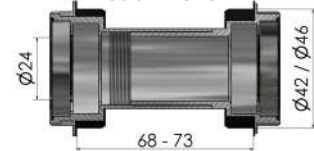

2018074
PF30 UT

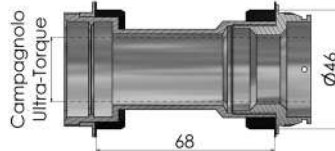

2019084
Shimano Fatbike ^{1 2}

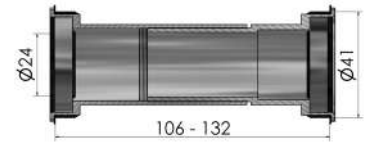

2019120
BB30 DUB
PF30 DUB

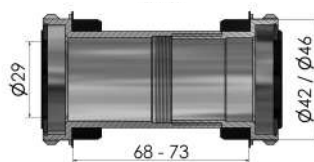

2019121
BB386 DUB

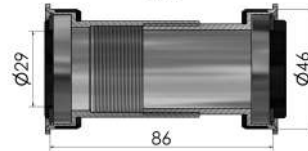

2020084
BB386 Shimano ^{1 2}

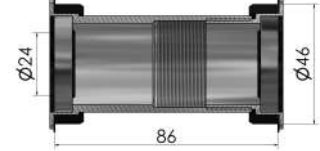

2020085
BB386 UT

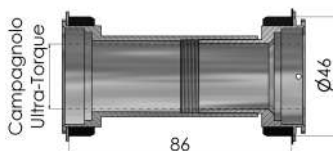

2020086
PF30 Fatbike

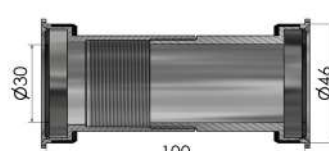

2020090
BB30 Praxis
PF30 Praxis

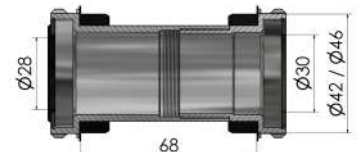

2020091
BB386 Praxis

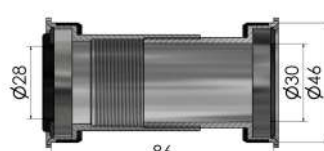

2021065
BB right Shimano ^{1 2}

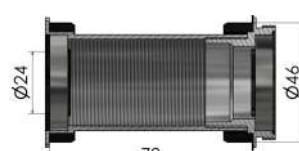

Scan the QR code for an online manual for (dis)assembling Elvedes twist fit bottom brackets using Twist fit tool kit.



PRESS FIT

- ¹ Convertible to GXP with GXP reducer kit (2018080)
- ² Convertible to FSA with FSA bearing caps (page 65)

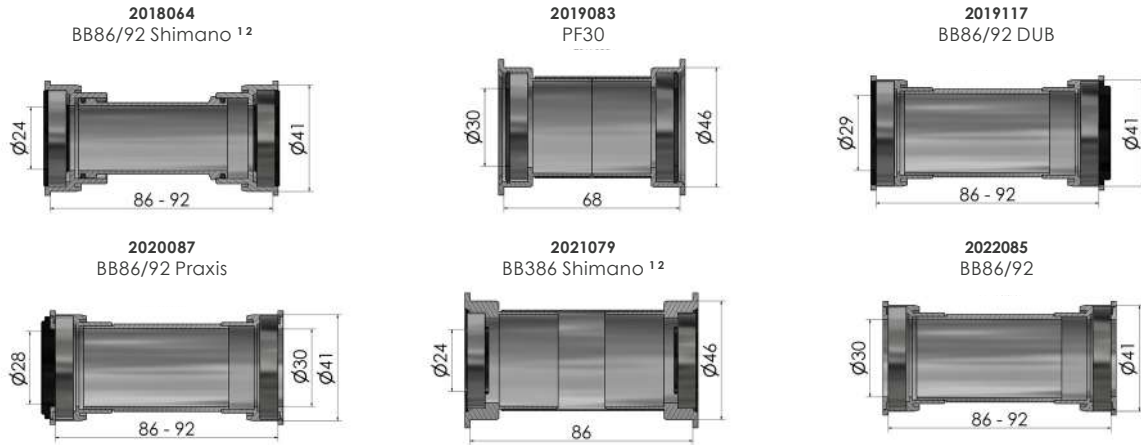

BEARING REPLACEMENT KIT

- ¹ Includes bearing caps for Shimano and FSA
- ² Convertible to GXP with GXP reducer kit (2018080)



2019086
Campagnolo Ultra - Torque



2019087
All Elvedes 24mm BB systems ^{1 2}



BRAKE

- DISC BRAKE SYSTEMS
- CALIPER ADAPTERS
- CALIPER BOLTS
- DISC BRAKE ROTORS
- DISC BRAKE PARTS
- DISC BRAKE PADS
- RIM BRAKE PADS

CABLE

- INNER CABLES
- SUPERFLEX
- OUTER CABLES
- CABLE KITS
- CABLE PARTS

HYDRO

- ORIGINAL BRANDS
- HYDRO COMPONENTS
- SHIMANO HYDRO COMPONENTS
- O-RINGS

ROTATION

- BEARINGS
- HEADSET BEARINGS
- HEADSET PARTS
- PULLEY WHEELS
- BOTTOM BRACKET GUIDE

BOTTOM BRACKETS

- BOTTOM BRACKET PARTS

TOOLS AND MAINTENANCE

- MAINTENANCE
- CABLE TOOLS
- HYDRO TOOLS
- MORE TOOLS
- BOTTOM BRACKET TOOLS

WORKSHOP

- TRANSIT
- BOXER
- PARTNER
- CADDY
- PADFINDER
- DISCOVERY
- BLEED STATION

ASSORTMENT BOX BOTTOM BRACKET SPACERS

2019070

Contains 157 pcs

Excludes 2022006 and 2022007



2022006

Spacer ring

Plastic
 $\text{Ø}30 \times \text{Ø}24 \times 0,2 \text{ mm}$
 20 pcs



2022007

Spacer ring

Plastic
 $\text{Ø}36 \times \text{Ø}30 \times 0,2 \text{ mm}$
 20 pcs



2019071

Spacer ring

Plastic
 $\text{Ø}30 \times \text{Ø}24 \times 0,5 \text{ mm}$
 20 pcs

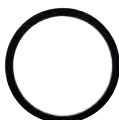

2019072

Spacer ring

Plastic
 $\text{Ø}30 \times \text{Ø}24 \times 1 \text{ mm}$
 20 pcs



2019073

Spacer ring

Plastic
 $\text{Ø}36 \times \text{Ø}30 \times 0,5 \text{ mm}$
 20 pcs



2019074

Spacer ring

Plastic
 $\text{Ø}36 \times \text{Ø}30 \times 1 \text{ mm}$
 20 pcs



2019075

Spacer ring

Aluminium
 $\text{Ø}38 \times \text{Ø}30 \times 2 \text{ mm}$
 6 pcs



2019076

Spacer ring

Aluminium
 $\text{Ø}38 \times \text{Ø}30 \times 5 \text{ mm}$
 4 pcs



2019077

Spacer ring

Aluminium
 $\text{Ø}38 \times \text{Ø}30 \times 7 \text{ mm}$
 3 pcs



2019078

Spacer ring

Aluminium
 $\text{Ø}38 \times \text{Ø}30 \times 9 \text{ mm}$
 2 pcs



2019079

Spacer ring

Aluminium
 $\text{Ø}38 \times \text{Ø}30 \times 11 \text{ mm}$
 2 pcs



2019080

Wave washer

Aluminium
 $\text{Ø}31 \times \text{Ø}22 \times 0,3 \text{ mm}$
 20 pcs



2019081

Wave washer

Aluminium
 $\text{Ø}31 \times \text{Ø}24 \times 0,6 \text{ mm}$
 20 pcs



2019082

Wave washer

Aluminium
 $\text{Ø}40,5 \times \text{Ø}32,8 \times 0,3 \text{ mm}$
 20 pcs



ASSORTMENT BOX BOTTOM BRACKET BEARING CAPS

2019056

2 pcs of every bearing cap
1 set GXP adapter



Scan code to discover
all bearing caps



2018081

40 mm with edge

Shimano
Type A
2 pcs



2018082

37 mm without edge

Shimano
Type B
2 pcs



2018083

40 mm with edge

FSA 24mm Mega Exo
Type C
2 pcs



2018084

37 mm without edge

FSA 24mm Mega Exo
Type D
2 pcs



2019064

40 mm without edge

FSA 19 mm Mega Exo
Type E
2 pcs



2019065

37 mm without edge

FSA 19 mm Mega Exo
Type F
2 pcs



2019066

40 mm without edge

Shimano
(fits Trek)
Type A0
2 pcs



2019067

40 mm without edge

FSA 24mm Mega Exo
(fits Trek)
Type C0
2 pcs



2018080

GXP reducer kit
24 mm to 22 mm



How to apply the
GXP reducer kit



BRAKE

DISC BRAKE SYSTEMS
CALIPER ADAPTERS
CALIPER BOLTS
DISC BRAKE ROTORS
DISC BRAKE PARTS
DISC BRAKE PADS
RIM BRAKE PADS

CABLE

INNER CABLES
SUPERFLEX
OUTER CABLES
CABLE KITS
CABLE PARTS

HYDRO

ORIGINAL BRANDS
HYDRO COMPONENTS
SHIMANO HYDRO COMPONENTS
O-RINGS

ROTATION

BEARINGS
HEADSET BEARINGS
HEADSET PARTS
PULLEY WHEELS
BOTTOM BRACKET GUIDE
BOTTOM BRACKETS

BOTTOM BRACKET PARTS

TOOLS AND MAINTENANCE

MAINTENANCE
CABLE TOOLS
HYDRO TOOLS
MORE TOOLS
BOTTOM BRACKET TOOLS

WORKSHOP

TRANSIT
BOXER
PARTNER
CADDY
PADFINDER
DISCOVERY
BLEED STATION

TOOLS AND MAINTENANCE

ETHANOL CLEANER
2018037
 40/60
 500 ml



ETHANOL CLEANER REFILL
2018089
 40/60
 500 ml



DISC CLEANER
2016020
 500 ml



GREASE GUN
2019035
 Labels included
 Grease not included
 80 ml
 Scan QR how to refill



ORIGINAL NOZZLE
2020113
 Short
 Spare part
 For grease gun



EXTENSION NOZZLE
2019036
 Long
 100mm
 For grease gun



SMALL NOZZLE
2023155
 Ø4 mm
 For rollerbrake
 For grease gun



ASSEMBLY PASTE
2020212
 Refill for grease gun
 White
 Not for carbon parts
 110g



ROLLERBRAKE GREASE
2019038
 Refill for grease gun
 Black
 110 g



LITHIUM GREASE
2019037
 Refill for grease gun
 Blue
 110g



MINERAL OIL BLUE
 For all mineral systems
 Colour based on
 Magura Royal Blood
2016006 100 ml
2015170 250 ml
2020239 1 000 ml



MINERAL OIL RED
 For all mineral systems

Colour based on
 Shimano SM-DB-OIL

2016005 100 ml
2015169 250 ml
2020238 1 000 ml



DOT OIL
 For all DOT systems

2015171 100 ml



CABLE PRICKER

2012029

Fits Ø4,1 and Ø4,9 mm outer cable

SPARE NEEDLE

2012029-1

For cable pricker
incl. fixing bolt



DEVELOPED BY **ELVEDES**



BRAKE

- DISC BRAKE SYSTEMS
- CALIPER ADAPTERS
- CALIPER BOLTS
- DISC BRAKE ROTORS
- DISC BRAKE PARTS
- DISC BRAKE PADS
- RIM BRAKE PADS

CABLE

- INNER CABLES
- SUPERFLEX
- OUTER CABLES
- CABLE KITS
- CABLE PARTS

HYDRO

- ORIGINAL BRANDS
- HYDRO COMPONENTS
- SHIMANO HYDRO COMPONENTS
- O-RINGS

CABLE CUTTER BASIC

2017070

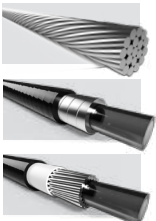

CABLE CUTTER PROFESSIONAL

2009018
Felco C7



ROTATION

- BEARINGS
- HEADSET BEARINGS
- HEADSET PARTS
- PULLEY WHEELS
- BOTTOM BRACKET GUIDE
- BOTTOM BRACKETS
- BOTTOM BRACKET PARTS

END CAP CRIMPING TOOL

2016093

For shift and brake end caps



FERRULE CRIMPING TOOL

2009019



TOOLS AND MAINTENANCE

MAINTENANCE

CABLE TOOLS

- HYDRO TOOLS
- MORE TOOLS
- BOTTOM BRACKET TOOLS

WORKSHOP

- TRANSIT
- BOXER
- PARTNER
- CADDY
- PADFINDER
- DISCOVERY
- BLEED STATION

HOSE MEASUREMENT KIT

NO MORE WASTING VALUABLE TIME LOOKING FOR COMPATIBLE FITTINGS!



2022058

Brake hose measurement tool kit with universal inserts

Convenient tool to measure any unidentified brake hose and select the fitting type of hose insert.

Contains 4 pieces of each type of insert.

Packed in a luxurious storage box.

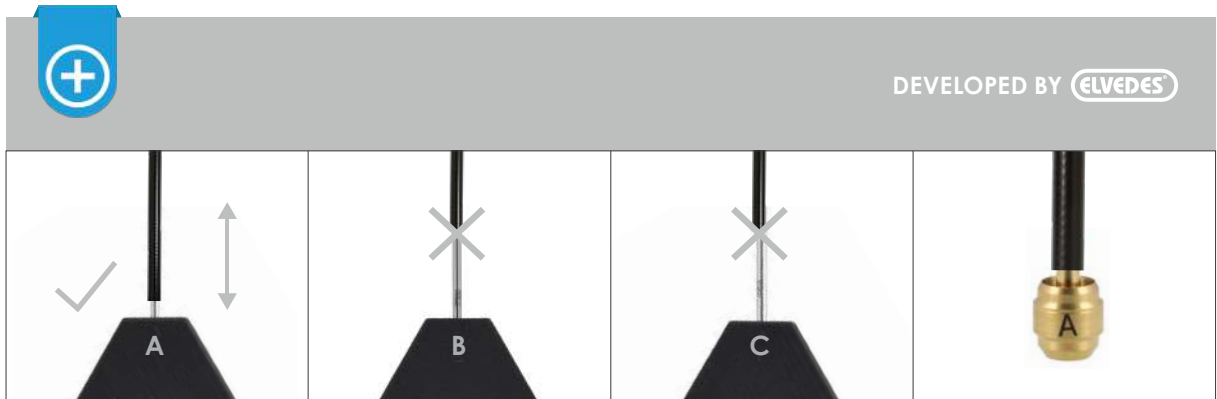

REFILL

2022059 10 pcs
Universal insert

Type A
For $\varnothing 2,1 - \varnothing 5,0$



2022060 10 pcs
Universal insert

Type B
For $\varnothing 2,3 - \varnothing 5,0$



2022061 10 pcs
Universal insert

Type C
For $\varnothing 2,5 - \varnothing 5,5$



PROFESSIONAL BLEEDING KIT

A complete kit per brand
Fits the Bleed Station (page 82-83)



Ensures clean and easy storage of your tools. Includes applicable high quality CNC adapters to prevent leakage. Includes 20 cm long tube(s) for great accessibility. Tubes are reusable for each adapter. Includes long lasting syringe(s) for mineral or DOT. Includes velcro straps to lend a helping hand.

- 2023102** Shimano incl. bleed cup with cap
- 2023103** SRAM
- 2023104** Magura
- 2023105** Tektro
- 2023106** Campagnolo



Scan QR
to see more



SPARE PARTS

Only compatible with parts for the professional bleeding kit

2023110

Adapter set for Shimano



2023111

Adapter set for SRAM



2023112

Adapter set for Magura



2023113

Adapter set for Tektro



2023114

Adapter set for Campagnolo



2023107

Link tube set
Incl. clips
2 pcs



2023108

Syringes for mineral oil
2 pcs



2023109

Syringes for DOT fluid
2 pcs



2023117

Syringe and bleed cup set for Shimano



2023115

Velcro straps
2 pcs



BRAKE

- DISC BRAKE SYSTEMS
- CALIPER ADAPTERS
- CALIPER BOLTS
- DISC BRAKE ROTORS
- DISC BRAKE PARTS
- DISC BRAKE PADS
- RIM BRAKE PADS

CABLE

- INNER CABLES
- SUPERFLEX
- OUTER CABLES
- CABLE KITS
- CABLE PARTS

HYDRO

- ORIGINAL BRANDS
- HYDRO COMPONENTS
- SHIMANO HYDRO COMPONENTS
- O-RINGS

ROTATION

- BEARINGS
- HEADSET BEARINGS
- HEADSET PARTS
- PULLEY WHEELS
- BOTTOM BRACKET GUIDE
- BOTTOM BRACKETS
- BOTTOM BRACKET PARTS

TOOLS AND MAINTENANCE

- MAINTENANCE
- CABLE TOOLS

HYDRO TOOLS

- MORE TOOLS
- BOTTOM BRACKET TOOLS

WORKSHOP

- TRANSIT
- BOXER
- PARTNER
- CADDY
- PADFINDER
- DISCOVERY
- BLEED STATION

HOSE PRICKER

2022051

For Ø5,0 and Ø5,5 mm hydraulic hose

SPARE NEEDLE

2022051-1

for hose pricker
incl. fixing bolt



DEVELOPED BY **ELVEDES**

BASIC BLEEDING KIT

2012095

For mineral and DOT oil.
Incl. adapters for Shimano, Magura, Hayes,
Avid / SRAM, Formula, Tektro and Elvedes



How to bleed a
Shimano brake system



BASIC BLEED ADAPTER SET

2020095
Shimano



2020224
SRAM /
Avid



2018043
Magura



2018047
Hayes



2018044
Tektro



2018048
Elvedes
HP4000



2018045
Formula



2022045
Promax



2022106
Nutt



BLEED BLOCK

2022080

Universal bleed
block

1 pce



BASIC OIL SYRINGES

2018040

Mineral oil syringes

2 pcs

2018041

DOT oil syringes

2 pcs



OPEN RING WRENCH 7 / 8 2017056

Specially designed for Shimano bleed bolt (7 mm)
For easy access to compression bolts (8 mm)



CROWS FOOT SPANNER 8MM 2020094

For compression bolts (8 mm)
Fits 1/4" torque wrench



BASIC HOSE CUTTER 2019042

For smooth and burr-free cutted hydraulic hose
Prevents leakage and damage of the hose

For consumer use

Spare blade included inside

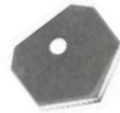

PROFESSIONAL HOSE CUTTER 2019124

For smooth and burr-free cutted hydraulic hose
Prevents leakage and damage of the hose



END PRESS 2017159

For fast and easily pressing inserts and banjos into hydraulic hose

Not suitable for Magura HS11/33



SPARE BLADE 2019232

For Hose cutter 2019124



SPARE INSERT DRIVER 2018112

For End press 2017159



BRAKE

- DISC BRAKE SYSTEMS
- CALIPER ADAPTERS
- CALIPER BOLTS
- DISC BRAKE ROTORS
- DISC BRAKE PARTS
- DISC BRAKE PADS
- RIM BRAKE PADS

CABLE

- INNER CABLES
- SUPERFLEX
- OUTER CABLES
- CABLE KITS
- CABLE PARTS

HYDRO

- ORIGINAL BRANDS
- HYDRO COMPONENTS
- SHIMANO HYDRO COMPONENTS
- O-RINGS

ROTATION

- BEARINGS
- HEADSET BEARINGS
- HEADSET PARTS
- PULLEY WHEELS
- BOTTOM BRACKET GUIDE
- BOTTOM BRACKETS
- BOTTOM BRACKET PARTS

TOOLS AND MAINTENANCE

- MAINTENANCE
- CABLE TOOLS

HYDRO TOOLS

- MORE TOOLS
- BOTTOM BRACKET TOOLS

WORKSHOP

- TRANSIT
- BOXER
- PARTNER
- CADDY
- PADFINDER
- DISCOVERY
- BLEED STATION

INTERNAL CABLE GUIDE

2018057

Accessories included
For more liners see page 41



How to use the
internal cable guide

MECHANIC HEADLAMP

2019040

For perfect visibility during
internal cable guideing
and frame inspection

Beam adjustment
function

Batteries (4x AAA)
not included



O-RING / SEAL REMOVAL TOOL SET

2020202

Specially designed for easily
removing and replacing o-rings
and bearing seals



MULTI TOOL

2018026

Multi tool for disc brake and Centra-lock rings



Discover all features



ACCESSORIES REPLACEMENT SET

2019270

For internal cable guide 2018057

Magnetic pull wire



Pull wire



Magnet connector



Di2 connector



Cable and hose connector



Inner cable connector



2-WAY CONNECTOR

2022068

For connecting outer cables and
hoses end-to-end



INNER TO OUTER CABLE CONNECTOR

2023182

For connecting a hose or outer cable
directly to a superflex pull cable



PICK-UP MAGNET TOOL

2020096

For easily picking up internal
cables, steel bearing
balls and more

40 mm



INNER WIRE TENSION TOOL

2019041

For shift and brake inner wires



DISC ALIGNMENT TOOL

2019043



TWIST FIT TOOL KIT

2018087

Tool kit to (dis)assemble all Elvedes twist fit, thread fit and SRAM DUB bottom brackets.

16T Hollowtech II - 42,5mm
12T SRAM DUB - 44mm
12T Elvedes - 48,5mm



How to use the Twist fit tool kit



BEARING SERVICE KIT

2018088

Tool kit to (dis)assemble bottom bracket bearings



How to use the Bearing service kit



BOTTOM BRACKET WRENCH

2018086

Bottom bracket wrench for all Elvedes twist fit and thread fit systems

16T Hollowtech II - 42,5mm
12T Elvedes - 48,5mm



SRAM DUB TOOL ADAPTER

2019069

For Elvedes Twist fit and thread fit and original SRAM DUB

12T SRAM DUB - 44mm
12T Elvedes - 48,5mm

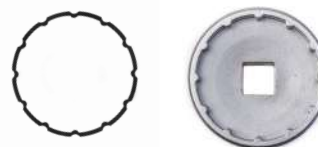

BRAKE

- DISC BRAKE SYSTEMS
- CALIPER ADAPTERS
- CALIPER BOLTS
- DISC BRAKE ROTORS
- DISC BRAKE PARTS
- DISC BRAKE PADS
- RIM BRAKE PADS

CABLE

- INNER CABLES
- SUPERFLEX
- OUTER CABLES
- CABLE KITS
- CABLE PARTS

HYDRO

- ORIGINAL BRANDS
- HYDRO COMPONENTS
- SHIMANO HYDRO COMPONENTS
- O-RINGS

ROTATION

- BEARINGS
- HEADSET BEARINGS
- HEADSET PARTS
- PULLEY WHEELS
- BOTTOM BRACKET GUIDE
- BOTTOM BRACKETS
- BOTTOM BRACKET PARTS

TOOLS AND MAINTENANCE

- MAINTENANCE
- CABLE TOOLS
- HYDRO TOOLS

MORE TOOLS

BOTTOM BRACKET TOOLS

WORKSHOP

- TRANSIT
- BOXER
- PARTNER
- CADDY
- PADFINDER
- DISCOVERY
- BLEED STATION

WORKSHOP



ELVEDES

ELVEDES

ELVEDES

 411.821	 411.822	 411.823
 411.824	 411.825	 411.826
 411.827	 411.828	 411.829

Rim brake pads
21 per quantity, not brake pad.

ELVEDES
bike components

TRANSIT

2016042

No displays included

Dimensions
97x180x41 cm

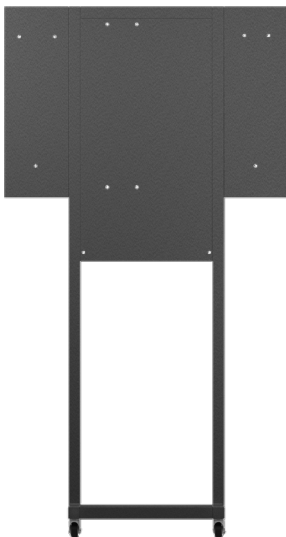

In order to increase efficiency in the workshop, Elvedes has developed a compact all-in-one mobile frame. This facilitates you to quickly and easily find all components you need for replacing cables and brake parts. No displays included. See page 76 - 81

5 full displays = Transit for free

BRAKE

- DISC BRAKE SYSTEMS
- CALIPER ADAPTERS
- CALIPER BOLTS
- DISC BRAKE ROTORS
- DISC BRAKE PARTS
- DISC BRAKE PADS
- RIM BRAKE PADS

CABLE

- INNER CABLES
- SUPERFLEX
- OUTER CABLES
- CABLE KITS
- CABLE PARTS

HYDRO

- ORIGINAL BRANDS
- HYDRO COMPONENTS
- SHIMANO HYDRO COMPONENTS
- O-RINGS

ROTATION

- BEARINGS
- HEADSET BEARINGS
- HEADSET PARTS
- PULLEY WHEELS
- BOTTOM BRACKET GUIDE
- BOTTOM BRACKETS
- BOTTOM BRACKET PARTS

TOOLS AND MAINTENANCE

- MAINTENANCE
- CABLE TOOLS
- HYDRO TOOLS
- MORE TOOLS
- BOTTOM BRACKET TOOLS

WORKSHOP

TRANSIT

- BOXER
- PARTNER
- CADDY
- PADFINDER
- DISCOVERY
- BLEED STATION

BOXER

2017027

Dimensions

53 x 36 x 36 cm

Fasteners included



Free choice of cable types!

3 volume boxes stainless inner cable
4 volume boxes outer cable
See page 27 + 32

Full display = display for free



PARTNER

2018115

Dimensions
53 x 14 x 7cm

Smart fix system



BRAKE

- DISC BRAKE SYSTEMS
- CALIPER ADAPTERS
- CALIPER BOLTS
- DISC BRAKE ROTORS
- DISC BRAKE PARTS
- DISC BRAKE PADS
- RIM BRAKE PADS

CABLE

- INNER CABLES
- SUPERFLEX
- OUTER CABLES
- CABLE KITS
- CABLE PARTS

HYDRO

- ORIGINAL BRANDS
- HYDRO COMPONENTS
- SHIMANO HYDRO COMPONENTS
- O-RINGS

ROTATION

- BEARINGS
- HEADSET BEARINGS
- HEADSET PARTS
- PULLEY WHEELS
- BOTTOM BRACKET GUIDE
- BOTTOM BRACKETS
- BOTTOM BRACKET PARTS

TOOLS AND MAINTENANCE

- MAINTENANCE
- CABLE TOOLS
- HYDRO TOOLS
- MORE TOOLS
- BOTTOM BRACKET TOOLS

WORKSHOP

- TRANSIT

- BOXER**

- PARTNER**

- CADDY

- PADFINDER

- DISCOVERY

- BLEED STATION

Free choice of cable parts!

10 jars
See page 37 - 41

Full display = display for free



CADDY
2017091

Dimensions
19,5 x 65 x 12,5 cm

Fasteners included



Free choice of rim brake pads!

Choose 3 boxes with
25 pairs rim brake pads

See page 23-25

Full display = display for free

PADFINDER

2017024

Dimensions
13 x 65 x 12,5 cm

Fasteners included



Free choice of disc brake pads!

Choose 4 boxes with
10 pairs disc brake pads

See page 17-21

Full display = display for free



BRAKE

- DISC BRAKE SYSTEMS
- CALIPER ADAPTERS
- CALIPER BOLTS
- DISC BRAKE ROTORS
- DISC BRAKE PARTS
- DISC BRAKE PADS
- RIM BRAKE PADS

CABLE

- INNER CABLES
- SUPERFLEX
- OUTER CABLES
- CABLE KITS
- CABLE PARTS

HYDRO

- ORIGINAL BRANDS
- HYDRO COMPONENTS
- SHIMANO HYDRO COMPONENTS
- O-RINGS

ROTATION

- BEARINGS
- HEADSET BEARINGS
- HEADSET PARTS
- PULLEY WHEELS
- BOTTOM BRACKET GUIDE
- BOTTOM BRACKETS
- BOTTOM BRACKET PARTS

TOOLS AND MAINTENANCE

- MAINTENANCE
- CABLE TOOLS
- HYDRO TOOLS
- MORE TOOLS
- BOTTOM BRACKET TOOLS

WORKSHOP

- TRANSIT
- BOXER
- PARTNER

CADDY

PADFINDER

- DISCOVERY
- BLEED STATION

DISCOVERY STARTER KIT

2020045

1 pair of each disc brake pad in organic compound

The Discovery can be used in 3 different settings:

1. Swing display (use additional arm)
2. Wall display
3. Counter display (use additional bottom base)

Necessary parts and fasteners included

Dimensions
38 x 65,5 x 15 cm

POSTER

2024002

Included with each Discovery
Separately available

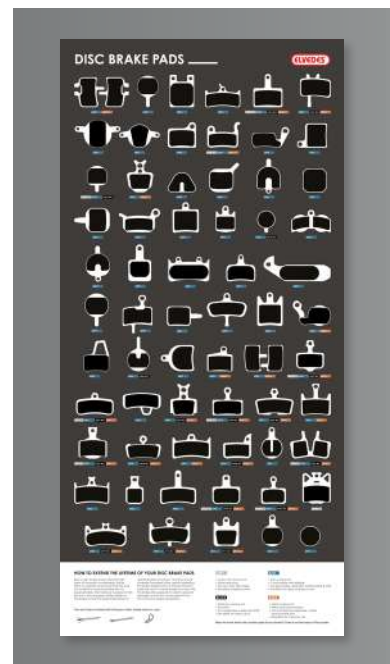

1 pair of each disc brake pad in organic compound

See page 17-21

Full display = display for free

DISCOVERY

2016074

The Discovery can be used in 3 different settings:

1. Swing display (use additional arm)
2. Wall display
3. Counter display (use additional bottom base)

Necessary parts and fasteners included

Dimensions
38 x 65,5 x 15 cm

POSTER

2024002

Included with each Discovery
Separately available

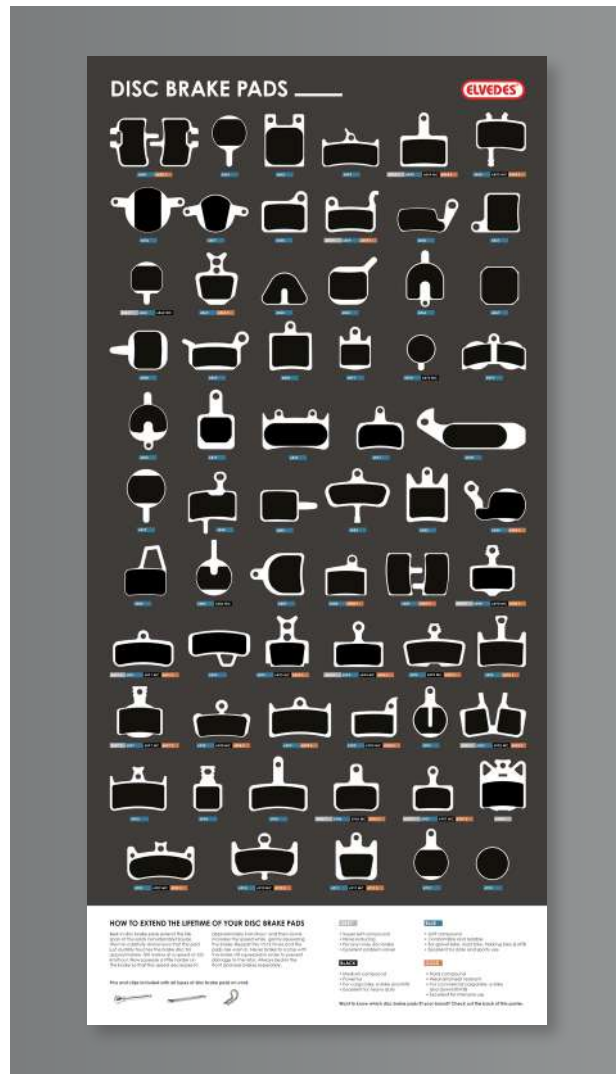

BRAKE

- DISC BRAKE SYSTEMS
- CALIPER ADAPTERS
- CALIPER BOLTS
- DISC BRAKE ROTORS
- DISC BRAKE PARTS
- DISC BRAKE PADS
- RIM BRAKE PADS

CABLE

- INNER CABLES
- SUPERFLEX
- OUTER CABLES
- CABLE KITS
- CABLE PARTS

HYDRO

- ORIGINAL BRANDS
- HYDRO COMPONENTS
- SHIMANO HYDRO COMPONENTS
- O-RINGS

ROTATION

- BEARINGS
- HEADSET BEARINGS
- HEADSET PARTS
- PULLEY WHEELS
- BOTTOM BRACKET GUIDE
- BOTTOM BRACKETS
- BOTTOM BRACKET PARTS

TOOLS AND MAINTENANCE

- MAINTENANCE
- CABLE TOOLS
- HYDRO TOOLS
- MORE TOOLS
- BOTTOM BRACKET TOOLS

WORKSHOP

- TRANSIT
- BOXER
- PARTNER
- CADDY
- PADFINDER

DISCOVERY

- BLEED STATION

Free choice of disc brake pads!

Choose 100 pairs disc brake pads to fill the Discovery

See page 17-21

Full display = display for free



BLEED STATION STARTER KIT

2023194

Workshop display to store up to 5 professional bleeding kits.

The starter kit includes 4 bleeding kits:

2023102 Shimano

2023103 SRAM

2023104 Magura

2023105 Tektro

Use the Bleed Station as counter or wall display.

Dimensions 41 x 29 x 16 cm



Professional bleeding kits included

See page 69

BLEED STATION

2023116

Workshop display to store up to 5 professional bleeding kits.

Bleeding kits not included.

Use the Bleed Station as counter or wall display.

Dimensions 41 x 29 x 16 cm



BRAKE

- DISC BRAKE SYSTEMS
- CALIPER ADAPTERS
- CALIPER BOLTS
- DISC BRAKE ROTORS
- DISC BRAKE PARTS
- DISC BRAKE PADS
- RIM BRAKE PADS

CABLE

- INNER CABLES
- SUPERFLEX
- OUTER CABLES
- CABLE KITS
- CABLE PARTS

HYDRO

- ORIGINAL BRANDS
- HYDRO COMPONENTS
- SHIMANO HYDRO COMPONENTS
- O-RINGS

ROTATION

- BEARINGS
- HEADSET BEARINGS
- HEADSET PARTS
- PULLEY WHEELS
- BOTTOM BRACKET GUIDE
- BOTTOM BRACKETS
- BOTTOM BRACKET PARTS

TOOLS AND MAINTENANCE

- MAINTENANCE
- CABLE TOOLS
- HYDRO TOOLS
- MORE TOOLS
- BOTTOM BRACKET TOOLS

WORKSHOP

- TRANSIT
- BOXER
- PARTNER
- CADDY
- PADFINDER
- DISCOVERY

BLEED STATION

Discover the Professional bleeding kits

See page 69





Bike components.



**Elvedes
Youtube
Channel**
scan QR

Elvedes.com

info@elvedes.com
+31 (0)416 374 597

Visiting address

Grutter 7
NL-5253 RM Nieuwkuijk
The Netherlands

Item no. 2024001

